

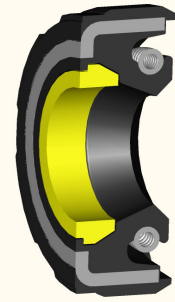

World Class Brand, World Class Manufacturing

NAK Standard Type

# CNB

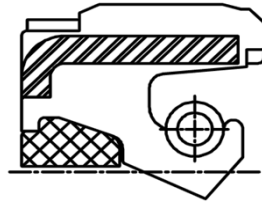

Shaft	Size		Measure mm. / inch	Drawing No.
	Bore	Width		
0.984	1.500	0.250	inch	22397
1.250	1.750	0.203	inch	11883
20	32	7.5	mm	47523
22	32	7	mm	33722
22	37	9	mm	22277
22.8	33.5	6	mm	12759
23	34.3	6.6	mm	25965
23	36.5	8.5	mm	42140
23	37	8.5	mm	51003
23	38	8	mm	48459
23	39	8.5	mm	51005
23	48.5	7.5	mm	21434
23.5	33.5	6	mm	13374
24	34	7	mm	05325
24	36	7	mm	33013
24	36.5	8.5	mm	47612
24	40	7	mm	07063
24	43	7	mm	33721
25	35	7	mm	05326
25	35	8	mm	38961
25	37	7.2	mm	10926
25	37	8.5	mm	59652
25	37	9	mm	39048
25	37.5	7	mm	13967
25	37.7	6.6	mm	49891
25	37.85	6.3	mm	53914
25	39.5	8.5	mm	41290
25	43	9	mm	13966
25	48	10	mm	52383
26	35	7	mm	41008
26	38	8.5	mm	16167
26	41	8.5	mm	38880
26	44	8.5	mm	41477
26	48	9.5	mm	51489



*World Class Brand, World Class Manufacturing*

NAK Standard Type

# CNB

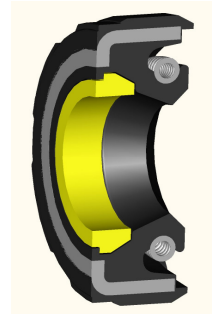
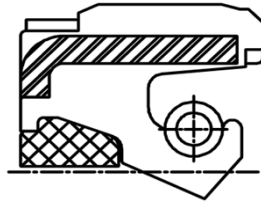

Shaft	Size		Measure mm. / inch	Drawing No.
	Bore	Width		
27	38	8.5	mm	51006
27.7	42	8.5	mm	40466
27.96	40	8	mm	41165
27.96	44.6	9	mm	41167
28	40	6.5	mm	48314
29	40	8.5	mm	50996
30	42	8	mm	44883
31	44.5	8.5	mm	51029
32	44.5	8.5	mm	48298
45	59	5.5	mm	34254
51.5	66	5.5	mm	39811
52	66	5.5	mm	34251
56	70	5.5	mm	34307





*World Class Brand, World Class Manufacturing*

NAK Standard Type

# CNB1

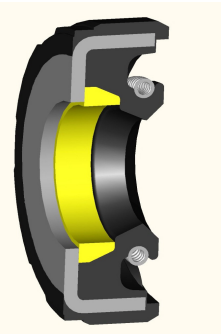
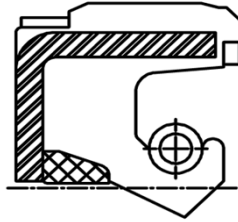

Shaft	Size		Measure mm. / inch	Drawing No.
	Bore	Width		
24	36.5	7	mm	58520
24	37	8.5	mm	59549
24	38	7	mm	59548
24	42	8	mm	54906
25	35	7	mm	59550
25	35	8.5	mm	50371
25.4	42.65	8	mm	54119
25.8	44	8	mm	48951
26	44	8.5	mm	44205
27	44	8.5	mm	32656
27.7	41.8	8.5	mm	57820
28	39	8.5	mm	42017
35	47	7	mm	52376





World Class Brand, World Class Manufacturing

NAK Standard Type

# CNB2

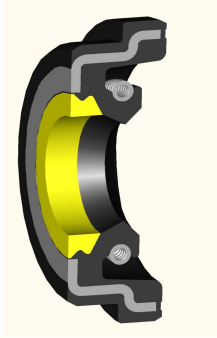
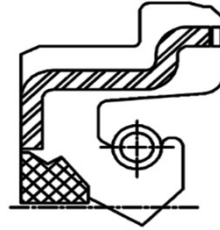

Shaft	Size		Measure mm. / inch	Drawing No.
	Bore	Width		
0.964	1.484/1.634	0.172/0.250	inch	43556
0.964	1.484/1.634	0.172/0.297	inch	26901
22	34.5/38	4.3/8	mm	53454
22.5	34.3/40.2	7.5	mm	36548
22.7	34/38	4.5/7.5	mm	57850
23	34.3/38	7.5	mm	41867
23	34.3/40.3	4.2/7.7	mm	56414
23	34.4/38.3	4.3/8	mm	49889
24	37.7/41.3	4.2/7.4	mm	51041
24.97	37.54/41.24	4.2/7.4	mm	44912
25	37.5/41.5	7.5	mm	46364
25	37.75/41.5	7.5	mm	39529
25	38/41	4.3/7.5	mm	39136
31	43.7/48	4.2/8.3	mm	56448











World Class Brand, World Class Manufacturing

NAK Standard Type

# CNB5

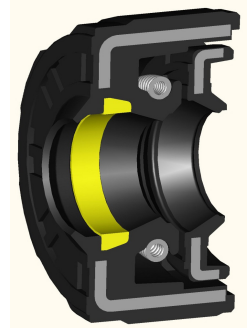
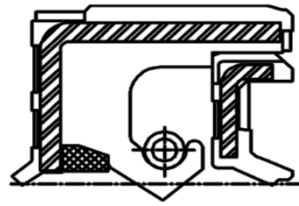

Shaft	Size		Measure mm. / inch	Drawing No.
	Bore	Width		

22	38.2	13/14.5	mm	54077
24	42.5	13/14.5	mm	54078
27	46	13/14	mm	29135

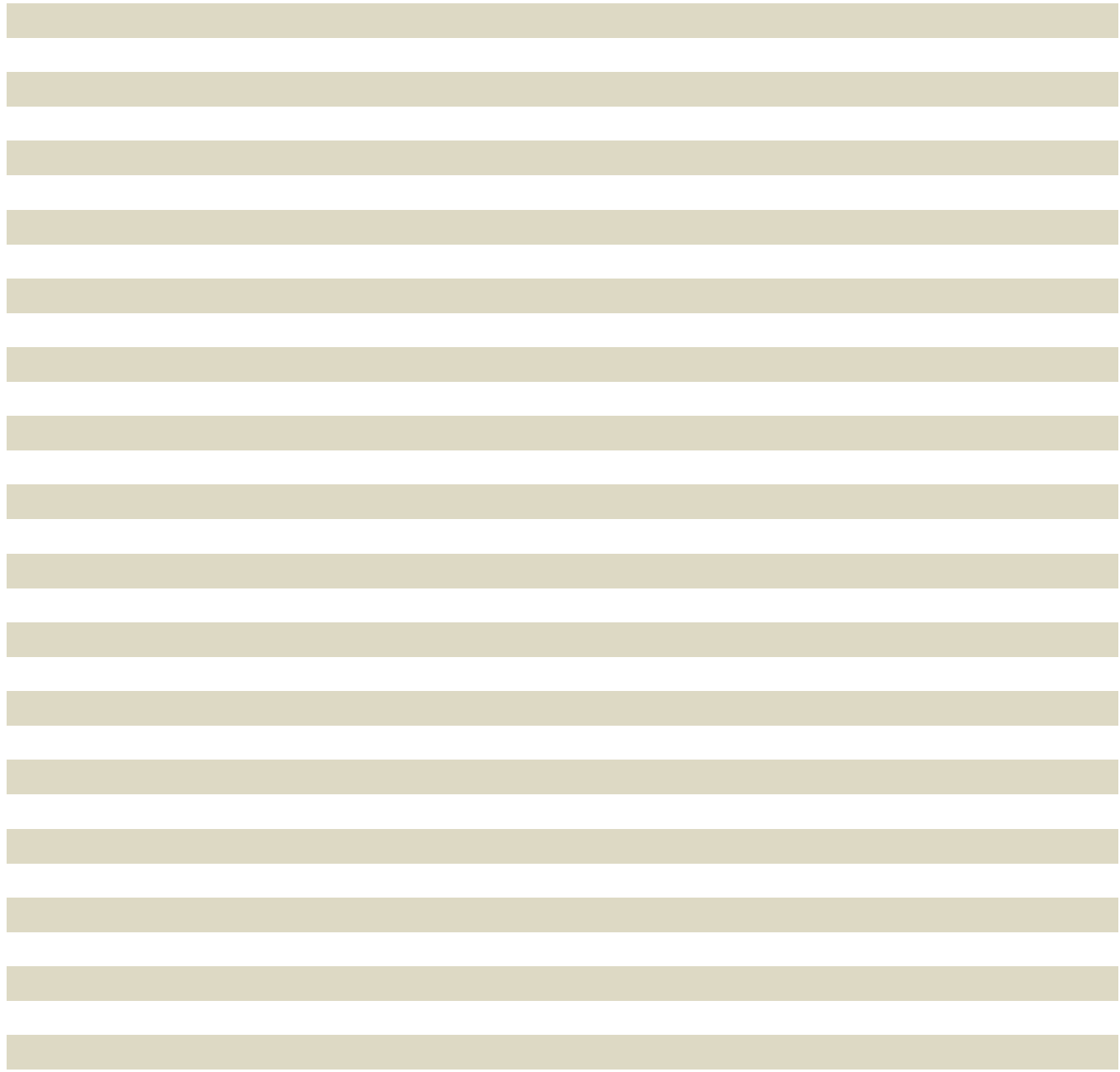





World Class Brand, World Class Manufacturing

NAK Standard Type

# CNB7

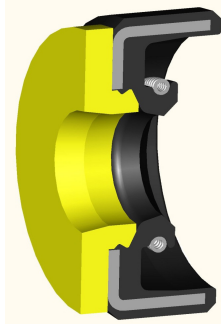
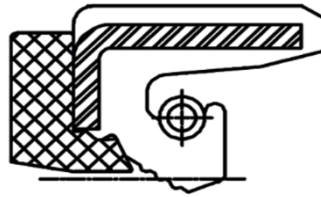

Shaft	Size		Measure mm. / inch	Drawing No.
	Bore	Width		
21.5	39.4	10/12.5	mm	54041
22	39.4	10/12.6	mm	54585
24	37	15/17	mm	58911
24.5	39.3	10/12.6	mm	54056
25	39.3	12.6	mm	48292
25	42.5	10/12.5	mm	58443
25	42.5	9/11.5	mm	59659
28	38	15/17	mm	48556
28	38	7	mm	23267
29.5	42.1	15.3/17.3	mm	54055
30	42	15.3/17.3	mm	44922
31.5	44.5	6.5	mm	58549
32	44.5	7	mm	48481







*World Class Brand, World Class Manufacturing*

NAK Standard Type

# CNB11

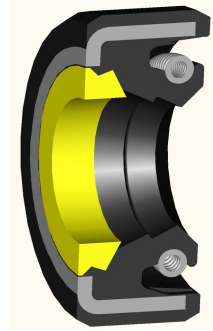
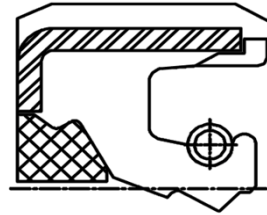

Shaft	Size		Measure mm. / inch	Drawing No.
	Bore	Width		
22	34	8.5	mm	48435
24	36	17.8	mm	47604
24	37	8.5	mm	47614
24	39	16.5	mm	54540
24	39	8.5	mm	41202
26	38	8	mm	51425
26	43	8	mm	51426
27.7	39.4	20.25	mm	49351
28	38	7	mm	57339
28	39	15	mm	52803
30	50	10	mm	56641

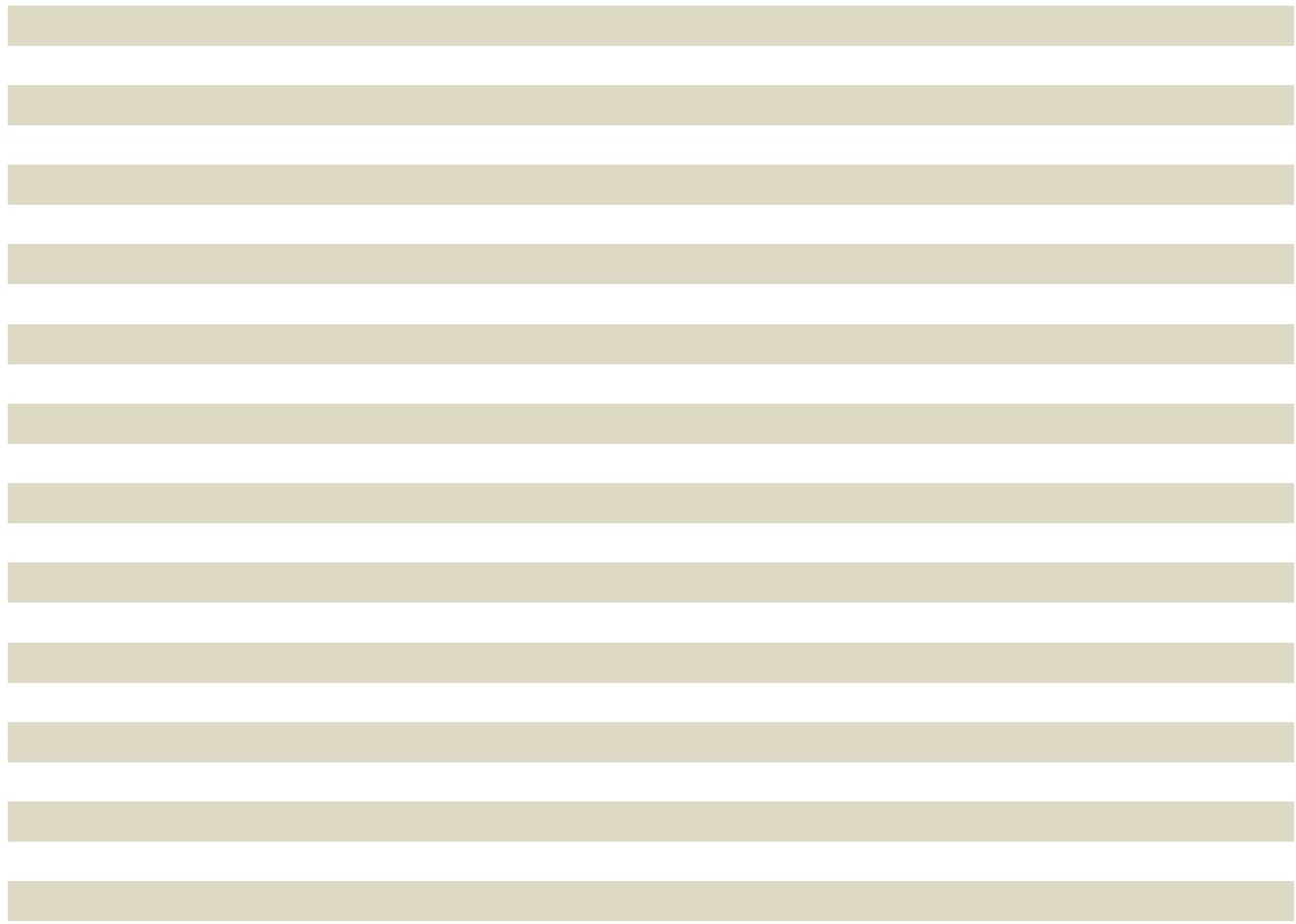







World Class Brand, World Class Manufacturing

NAK Standard Type

# CNB13-BR

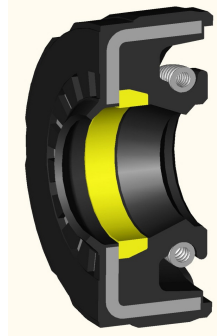
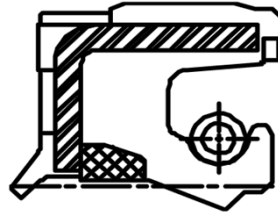

Shaft	Size		Measure mm. / inch	Drawing No.
	Bore	Width		
27	46	9.5	mm	43994
27.7	42	9/10	mm	48215

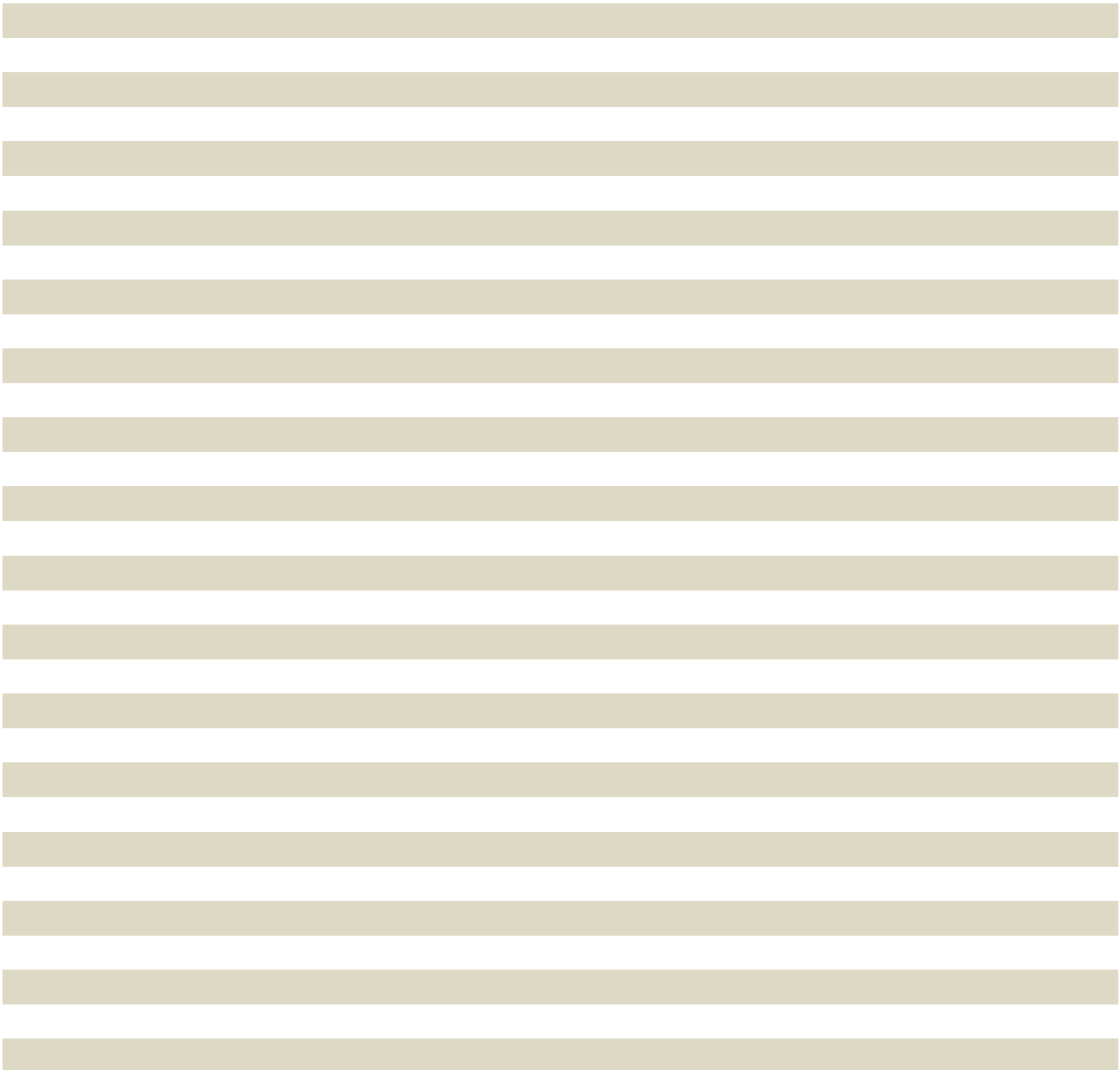





World Class Brand, World Class Manufacturing

NAK Standard Type

# CNB17

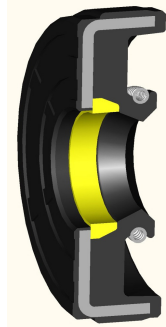
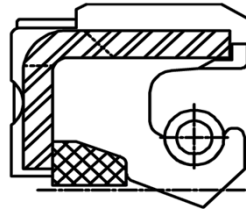

Shaft	Size		Measure	Drawing No.
	Bore	Width	mm. / inch	

27

46

8

mm

57389

Blank area for additional specifications or notes.



World Class Brand, World Class Manufacturing

NAK Standard Type

# CNB18

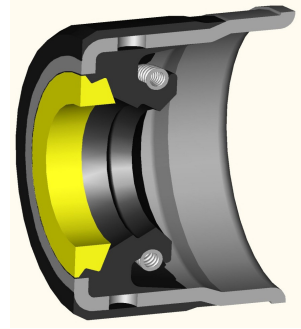
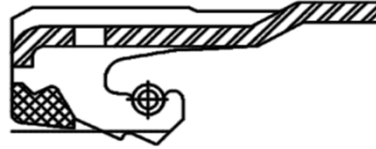

Shaft	Size		Measure mm. / inch	Drawing No.
	Bore	Width		

28

39

15

mm

57338

Blank area for additional specifications or notes.







World Class Brand, World Class Manufacturing

NAK Standard Type

# CNB20

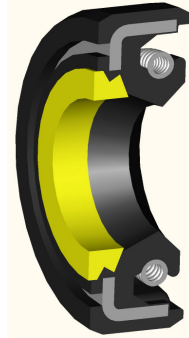
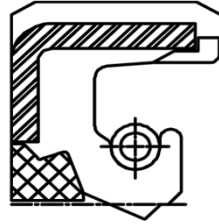

Shaft	Size		Measure mm. / inch	Drawing No.
	Bore	Width		
0.964	1.484	0.250	inch	50342
22.75	34.3	6.6	mm	25966
23	34.3	6.35	mm	48480
23	34.3	6.7	mm	57854
23	34.4	6.35	mm	49390
23	34.5	6.35	mm	41036
23	34.5	6.6	mm	41889
25	37.5	6.5	mm	29154
25	40	8.6	mm	47126
27.5	39.4	6.5	mm	47567
28	41	8.5	mm	47541
30	54.5	8	mm	51112









*World Class Brand, World Class Manufacturing*

NAK Standard Type

# GNB

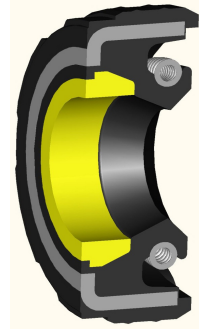
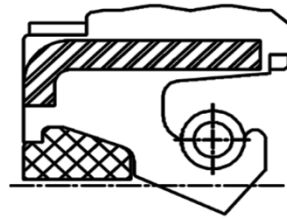

Shaft	Size		Measure mm. / inch	Drawing No.
	Bore	Width		
24	36	8	mm	51039
24	36.5	7.5	mm	40407
24.8	37.65	6.5	mm	56959
24.99	37.54	7	mm	48857
24.99	43	9	mm	33014
25	37.65	6.6	mm	56944
25.5	37.5	8	mm	39716
25.5	38.5	8.5	mm	33720
25.5	39	8.5	mm	33719
25.5	39.5	8	mm	39717
25.5	41.1	8	mm	39880
27	40	6.9	mm	48512
28	41	8	mm	29158







World Class Brand, World Class Manufacturing

NAK Standard Type

# GNB2

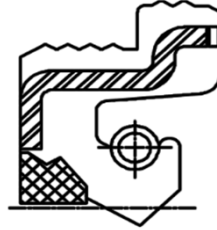

Shaft	Size		Measure mm. / inch	Drawing No.
	Bore	Width		
23	34.2/38	4.3/7.5	mm	51011
23	34.2/38	8	mm	38682
23	34.2/38	8.8	mm	50874
30	42.5/49	7.5/11	mm	59588

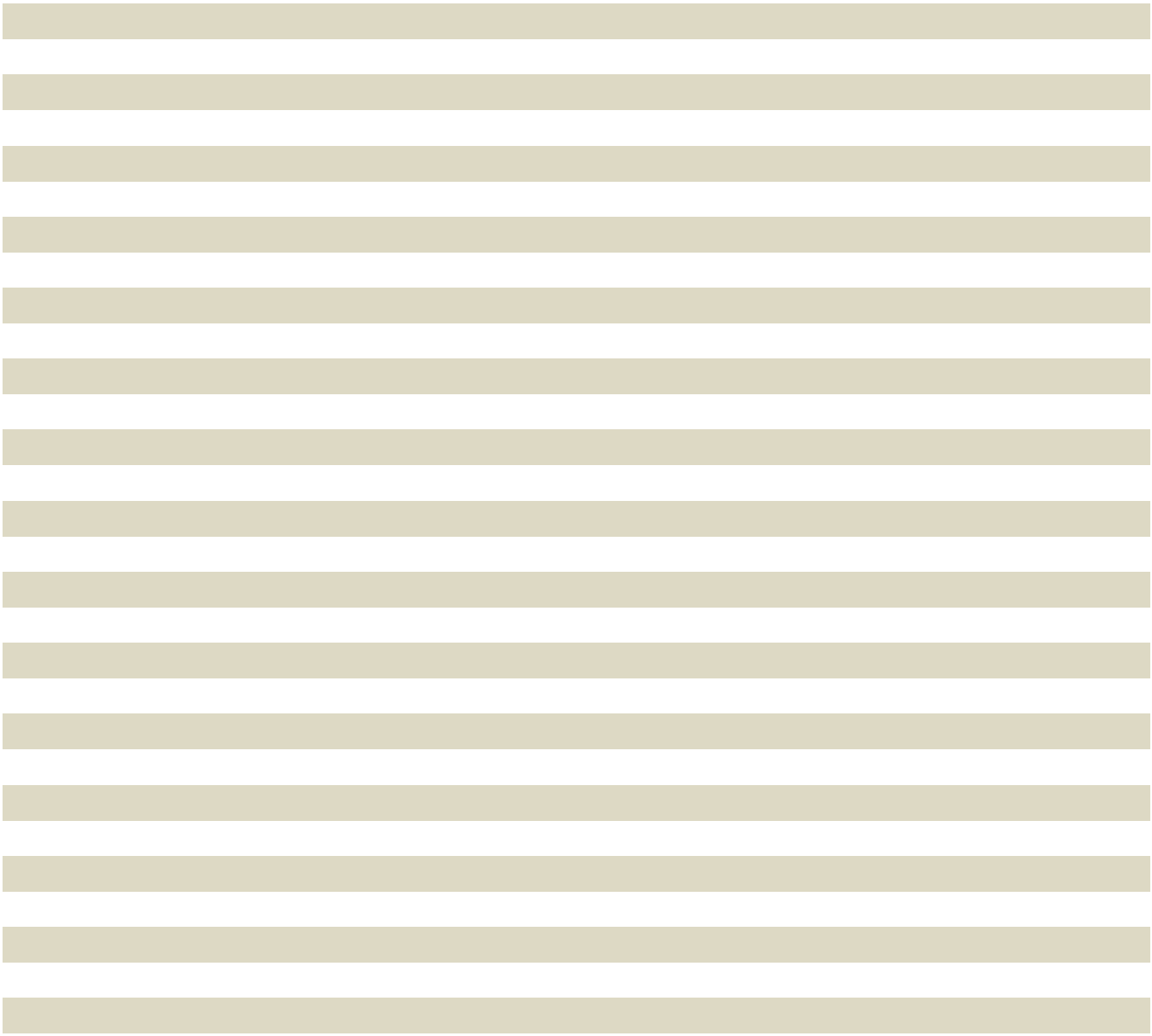













World Class Brand, World Class Manufacturing

NAK Standard Type

# GNB15-BR

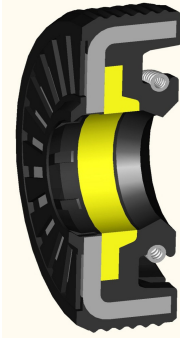
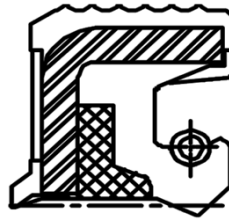

Size		Measure		Drawing No.
Shaft	Bore	Width	mm. / inch	

57	74.6	8.5/9.3	mm	48490
----	------	---------	----	-------

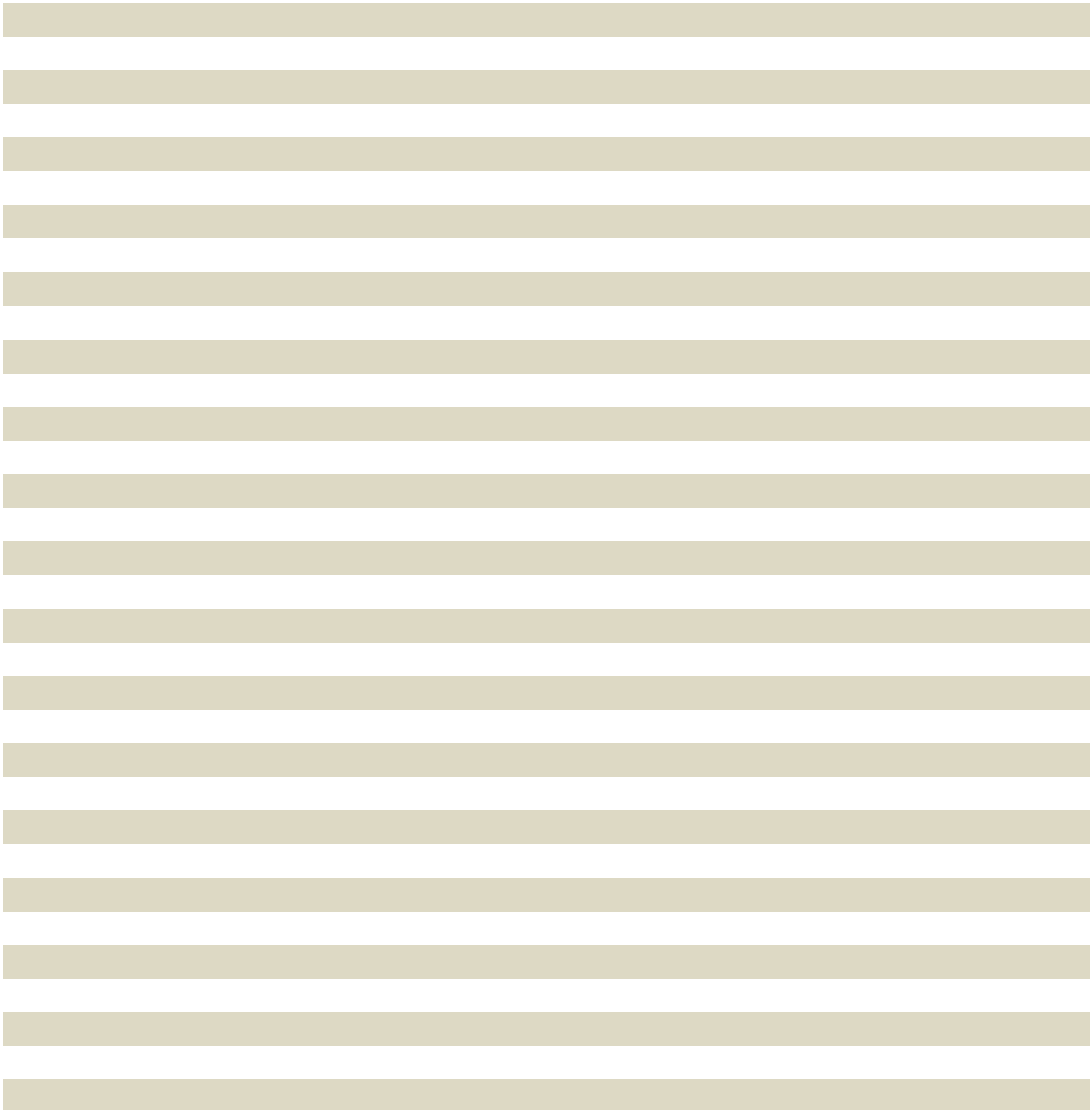





*World Class Brand, World Class Manufacturing*

NAK Standard Type

# GNB20



Shaft	Size		Measure mm. / inch	Drawing No.
	Bore	Width		
24.99	37.54	7	mm	48668
25	37	7	mm	48306
25	38.2	7.2	mm	10925
28	39.64	6.5	mm	54676
31.5	43.5	6.5	mm	56449
32	44.5	6.5	mm	47291
32	44.5	6.8	mm	49396

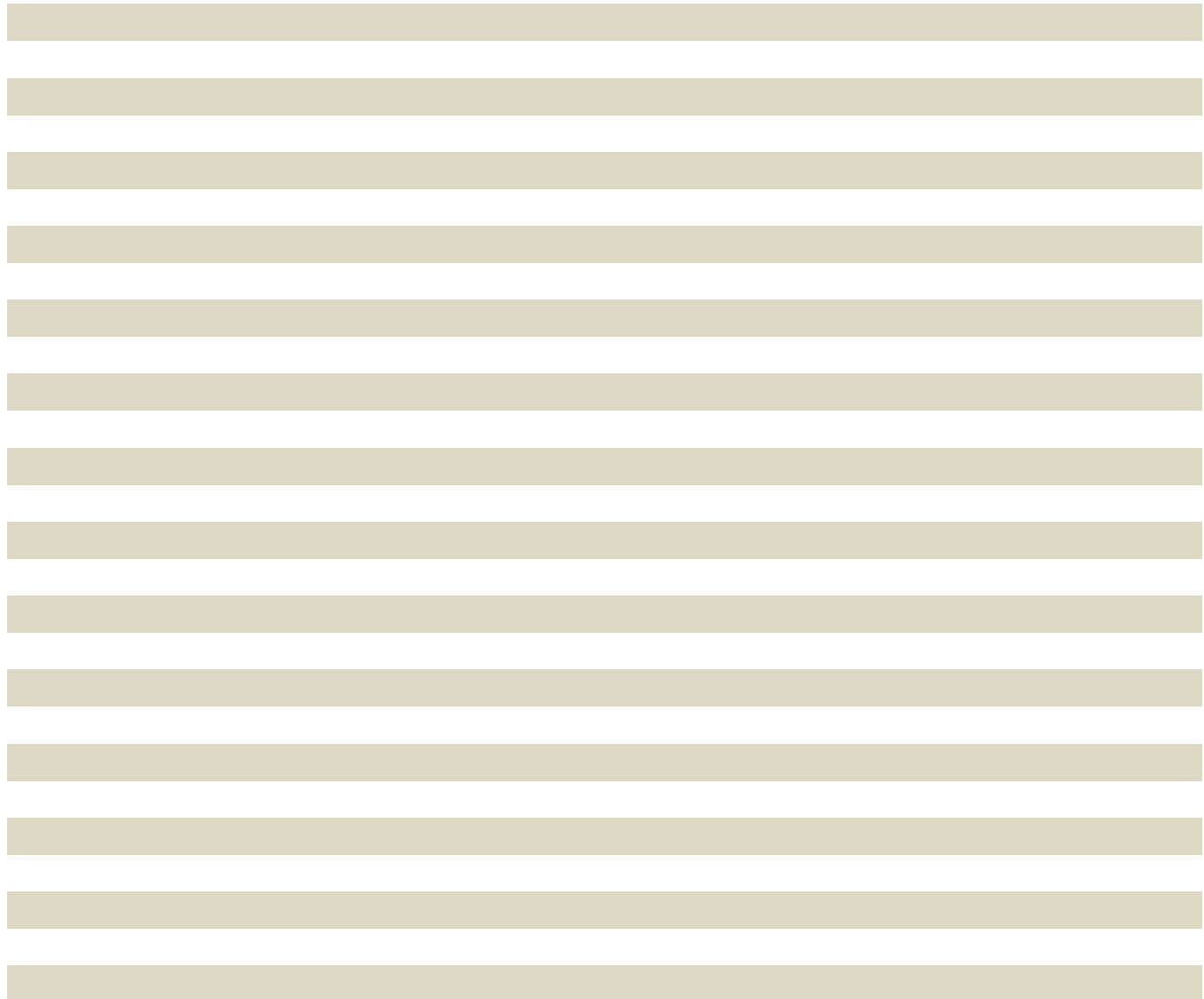



World Class Brand, World Class Manufacturing

NAK Standard Type

# GNB22

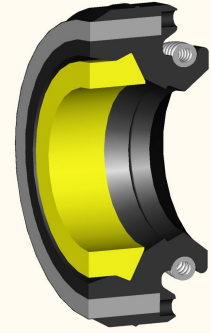
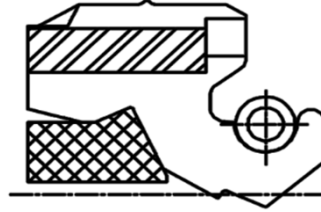

Shaft	Size		Measure	Drawing No.
	Bore	Width	mm. / inch	

23	32.6	5.5/7.5	mm	54292
23	32.7	5.5/7.5	mm	50537
25	34.7	5.7/8	mm	54102

Blank area for additional information or notes.







*World Class Brand, World Class Manufacturing*

NAK Standard Type

# SC4P

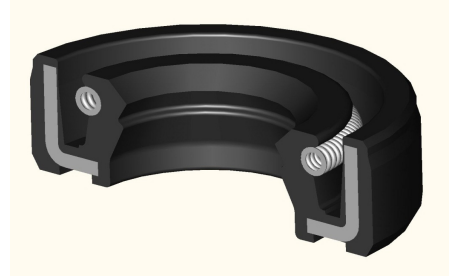

Shaft	Size		Measure mm. / inch	Drawing No.
	Bore	Width		
1.181	1.614	0.256	inch	33939
1.266	1.688	0.266	inch	50577
23	34	6.5	mm	49423
23	38	6.5	mm	30341
26	38	6.5	mm	54075
26	38	7	mm	59709
27	38	5.5	mm	30906
27.75	37.3	6.5	mm	59692
28	38	7	mm	20741
30	41.1	6.5	mm	59164
32	44	10	mm	56770
42	58	10	mm	56771











*World Class Brand, World Class Manufacturing*

NAK Standard Type

# SCN2P

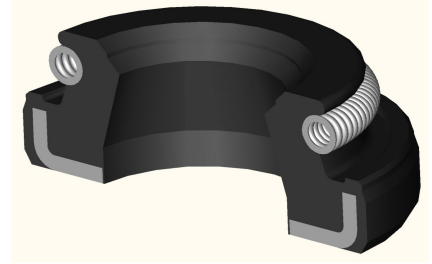
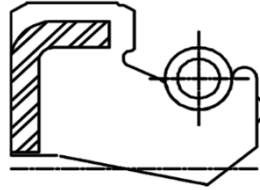

Shaft	Size		Measure mm. / inch	Drawing No.
	Bore	Width		
1.063	1.454	0.156/0.280	inch	47626
23	30	2/4.7	mm	48783
23.36	29.75	4/6	mm	54291
25	35	3.8/7.5	mm	39508
27	37	3.5/7	mm	54563

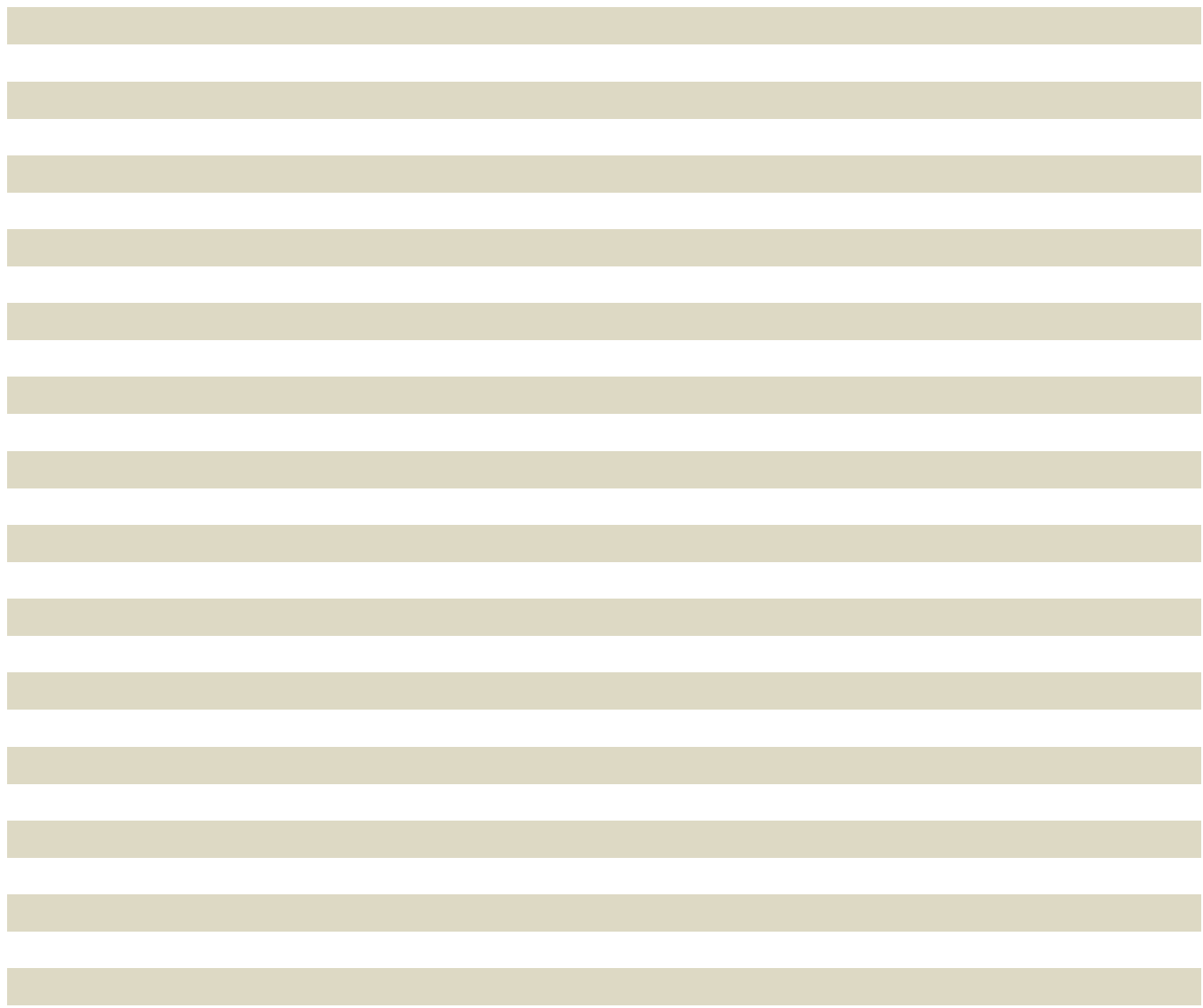











*World Class Brand, World Class Manufacturing*

NAK Standard Type

# SGNP

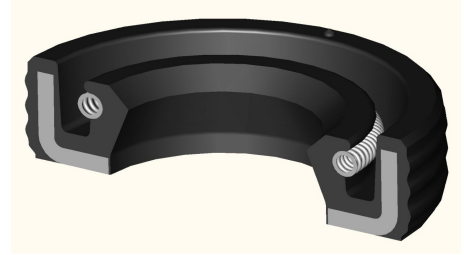
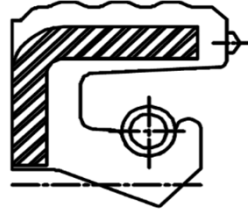

Shaft	Size		Measure mm. / inch	Drawing No.
	Bore	Width		
0.953	1.328	0.181	inch	56460
23.5	29.9	4.5	mm	51463
25	34	5	mm	56789
26	37	5	mm	49860
27.5	37.8	5.5	mm	56432
28.5	37.5	5	mm	54543

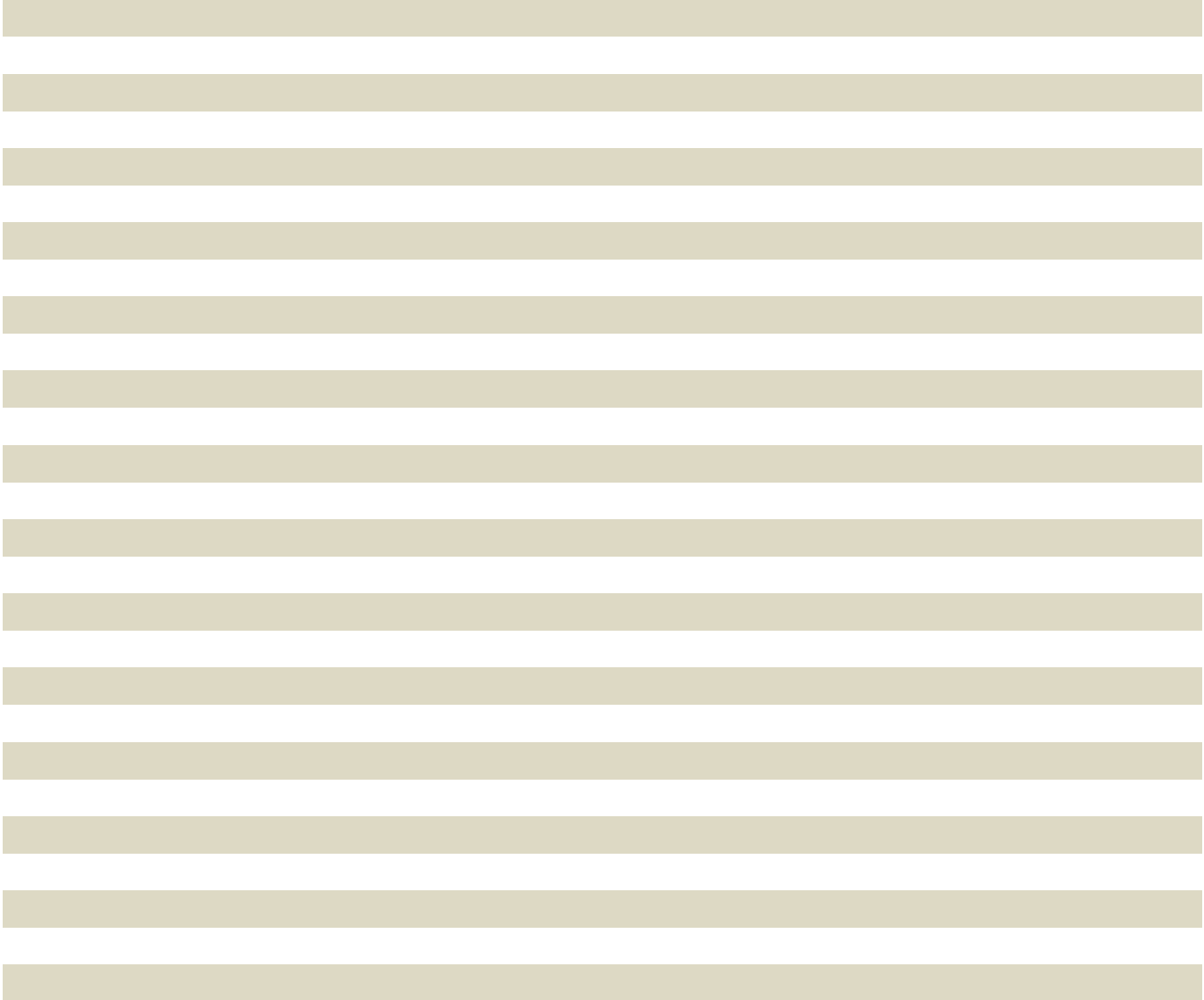









World Class Brand, World Class Manufacturing

NAK Standard Type

# TC4P

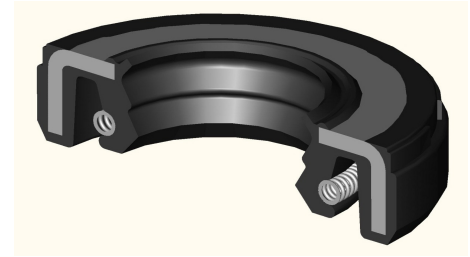
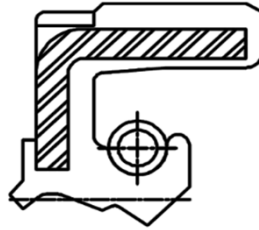

Shaft	Size		Measure mm. / inch	Drawing No.
	Bore	Width		
0.785	1.209	0.188/0.234	inch	40342
0.781	1.188	0.203/0.250	mm	54733
17	30	6/6.5	mm	48439
18	30	6.4/7	mm	38892
18	32	6	mm	53197
18	32	6/7	mm	32990
18.7	29	7/7.5	mm	50540
18.7	35	7	mm	34636
18.75	30	5/5.5	mm	29979
19	28	5/5.5	mm	48440
19	29	4.5/5.5	mm	48859
19	29.2	7/7.8	mm	57810
19	29.2	7/8	mm	59707
19	30	5/5.5	mm	57808
19	30	5.5/6	mm	44874
19	32	6	mm	30342
19	32	6/7	mm	50789
19	32	7/7.8	mm	54732
19	32	7/8	mm	59067
19	35.7	6.5/7.5	mm	56854
19	37	6.5/8.2	mm	47127
19	38	7/7.5	mm	49395
19.05	34.60	6.3/7.3	mm	30539
19.05	37	6.5/7.5	mm	36302
20	30	5/5.5	mm	49856
20	32.5	7/7.5	mm	44175
20	34	7/7.6	mm	57292
20	39.62	6.35	mm	53810
20	42.3	9.3	mm	30354
22	34	7	mm	44242
22.3	32.2	5.1/5.6	mm	56412
23	35	6.5/7	mm	48441
24	36	5.3/6.1	mm	54601
24	37	7/7.5	mm	56497



*World Class Brand, World Class Manufacturing*

NAK Standard Type

# TC4P

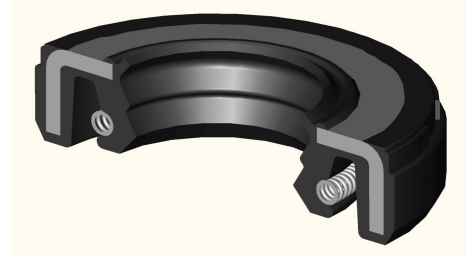
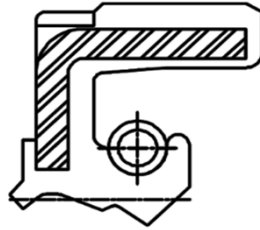

Shaft	Size		Measure mm. / inch	Drawing No.
	Bore	Width		
25	34	6/6.4	mm	30355
25	34	6.2/6.5	mm	55126
25	36	5/5.5	mm	29980
25	38	7/7.8	mm	30903
25	40	6.5/7.2	mm	54072
25	40	7.6/8.9	mm	51097
25	42	6.4/6.8	mm	41318
26	35	7/7.5	mm	48455
26	35.5	6/6.35	mm	59516
28	38	7/7.5	mm	48444
28	38.3	5/5.2	mm	48223
32	44	6.7	mm	44243
32	45	9/10	mm	45198
32.5	43	6.4	mm	57822





*World Class Brand, World Class Manufacturing*

NAK Standard Type

# TC4P1

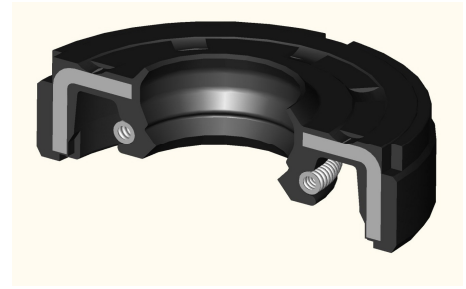

Shaft	Size		Measure mm. / inch	Drawing No.
	Bore	Width		
19.05	34.6	6.2/7.2	mm	59741
20	41.5	6.3/8.5	mm	59529
22	37	7/8	mm	59589
26	38	6.5/7	mm	59569
28	36.64	6.2/6.7	mm	59570
32	44	10/11	mm	59925
42	58	10/11	mm	59923

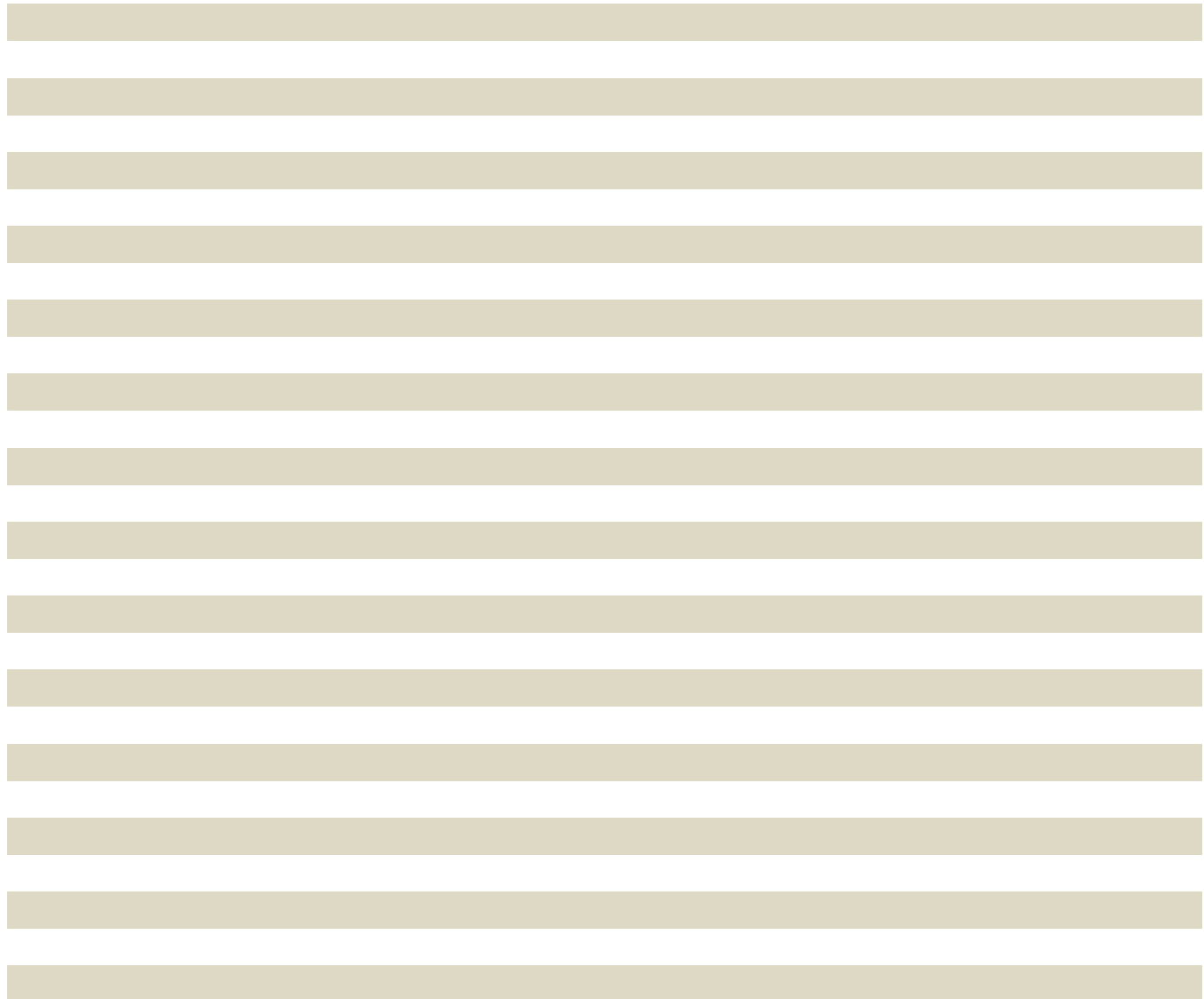



World Class Brand, World Class Manufacturing

NAK Standard Type

# TC4P-PL

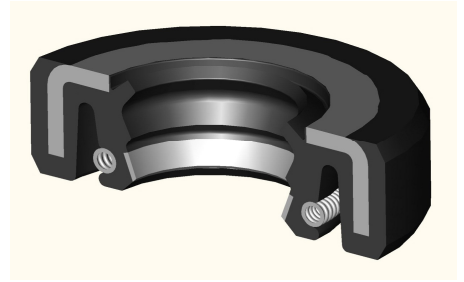
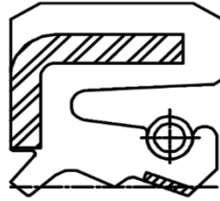

Shaft	Size		Measure mm. / inch	Drawing No.
	Bore	Width		

22.216

35

7

mm

49422

Blank area for additional specifications or notes.





*World Class Brand, World Class Manufacturing*

NAK Standard Type

# TC42P

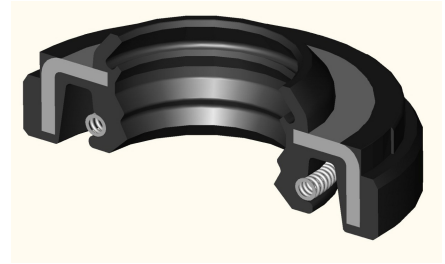
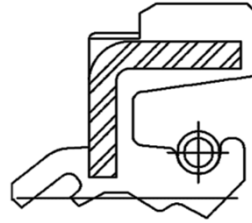

Shaft	Size		Measure mm. / inch	Drawing No.
	Bore	Width		
18.5	34.6	6.2/9.2	mm	59011
18.75	30	5/7.3	mm	58306
19	34.6	6.2/9.2	mm	59010
19	37	6.5/9	mm	59024
19.05	30	5/7.3	mm	58194
20	30	5.3/6.7	mm	50966
23.5	36.5	6.8/8.2	mm	51118

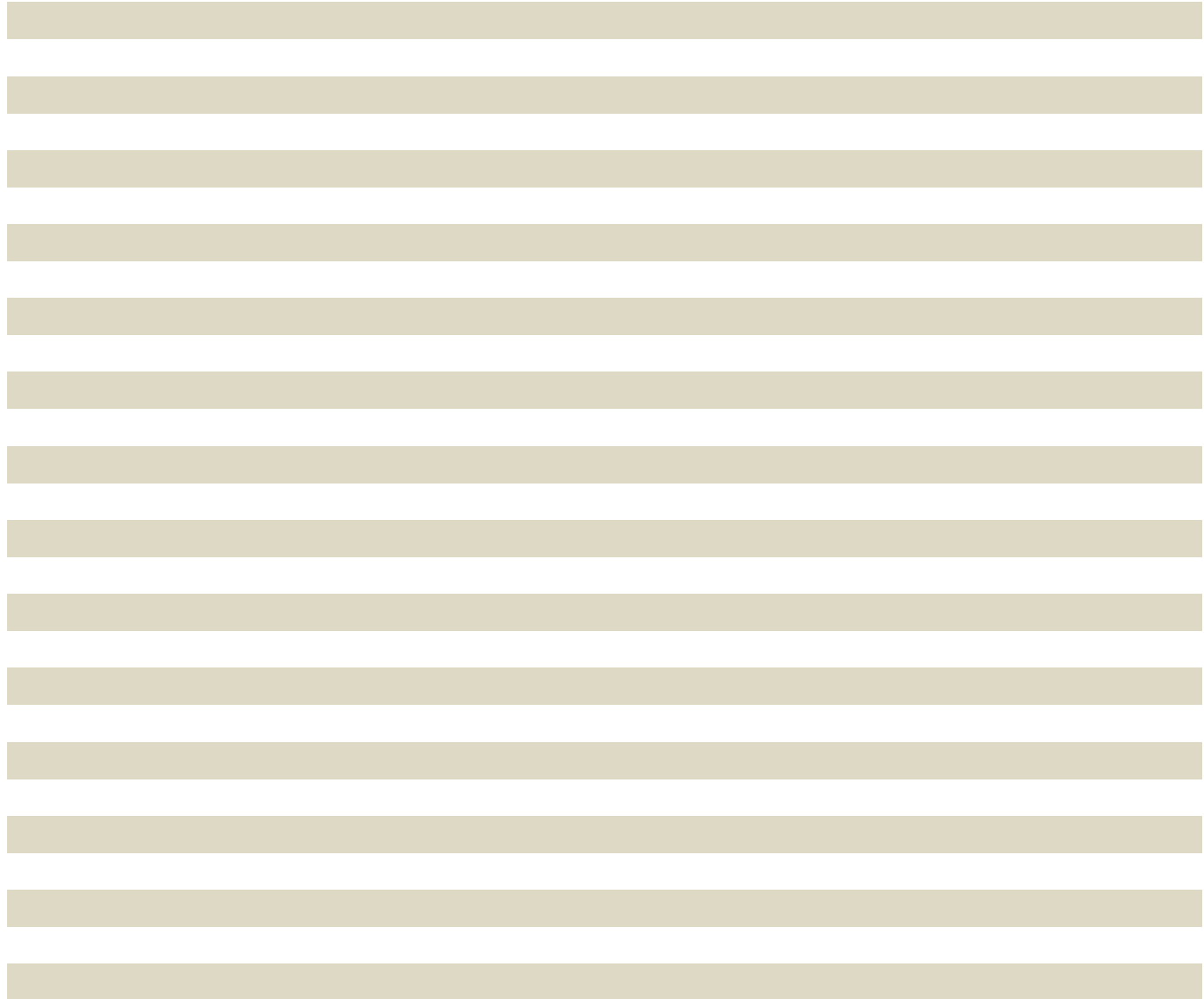



World Class Brand, World Class Manufacturing

NAK Standard Type

# TCN1P

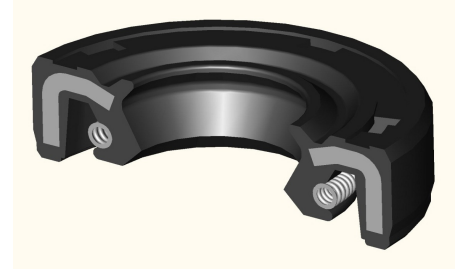

Shaft	Size		Measure mm. / inch	Drawing No.
	Bore	Width		
20	32	6	mm	58591
25	42	10	mm	51516



World Class Brand, World Class Manufacturing

NAK Standard Type

# TCN2P

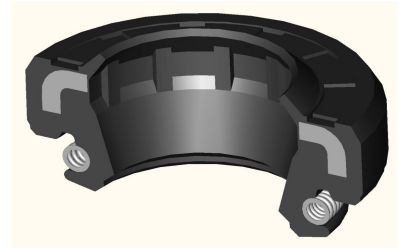
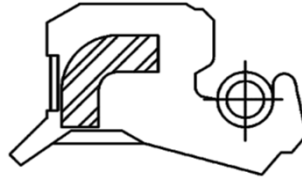

Shaft	Size		Measure mm. / inch	Drawing No.
	Bore	Width		

26

34

4.5/7

mm

40686

Blank area for additional specifications or notes.





*World Class Brand, World Class Manufacturing*

NAK Standard Type

# TCNP

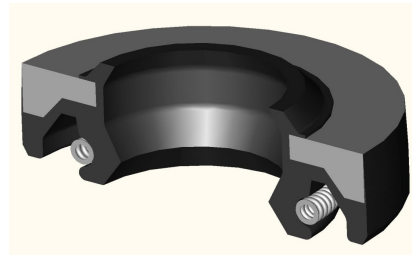
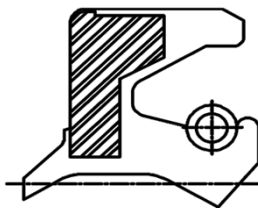

Shaft	Size		Measure mm. / inch	Drawing No.
	Bore	Width		
26	38	5.6/7.5	mm	48511
27	38.1	5.66/7.37	mm	57926
27	38.2	5.8/7.5	mm	51998







*World Class Brand, World Class Manufacturing*

NAK Standard Type

# TCP

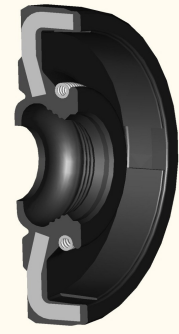

Shaft	Size		Measure	Drawing No.
	Bore	Width	mm. / inch	

26	38	5.8/7.5	mm	47586
----	----	---------	----	-------

Blank area for additional specifications or notes.





World Class Brand, World Class Manufacturing

NAK Standard Type

# TG4P

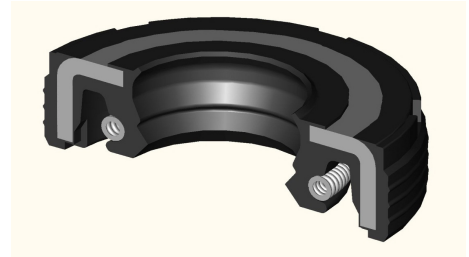
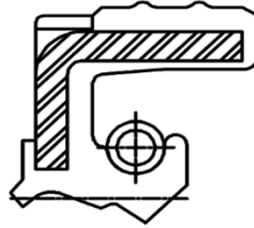

Shaft	Size		Measure mm. / inch	Drawing No.
	Bore	Width		
16	28	7	mm	36750
18	35	7	mm	36751
19	28	5.5/6	mm	47901
19	29	5.5/6	mm	47929
19	30	6/6.5	mm	54697
19	32	7/7.8	mm	51996
19	32	7/8	mm	51423
19	34.5	6.5/9.5	mm	48107
19	35	5/5.5	mm	30606
19	35	5/5.7	mm	47643
19	38	7/7.8	mm	32281
19	38	7.2/8	mm	32313
19.06	28.94	4.4/5.65	mm	48637
19.06	34.62	6.3/7.1	mm	53789
20	32	6.4	mm	53331
22	32	5/6	mm	53266
22	32	7/8	mm	55187
22	35	6.5/7	mm	56426
22	35	7/7.8	mm	32216
23.5	32.5	5/5.3	mm	54546
24	33	5/5.5	mm	30607
24	33	5/5.7	mm	49124
25	35	7/7.5	mm	32283
25	38	7/7.8	mm	32220
25	40	7/7.9	mm	51079
26	35.5	6.8/7.3	mm	33539
26	37	7/8	mm	53334
26	42	7	mm	35315
28	38	6.5/7	mm	47354
28	40	6/6.5	mm	58311
30	42	7	mm	36748
30	42	7/7.5	mm	45173
30	42	7/7.9	mm	51080

