

# TPSK



**NAK**<sup>TM</sup>

ISO-9001/14001

ISO/TS-16949

OHSAS-18001

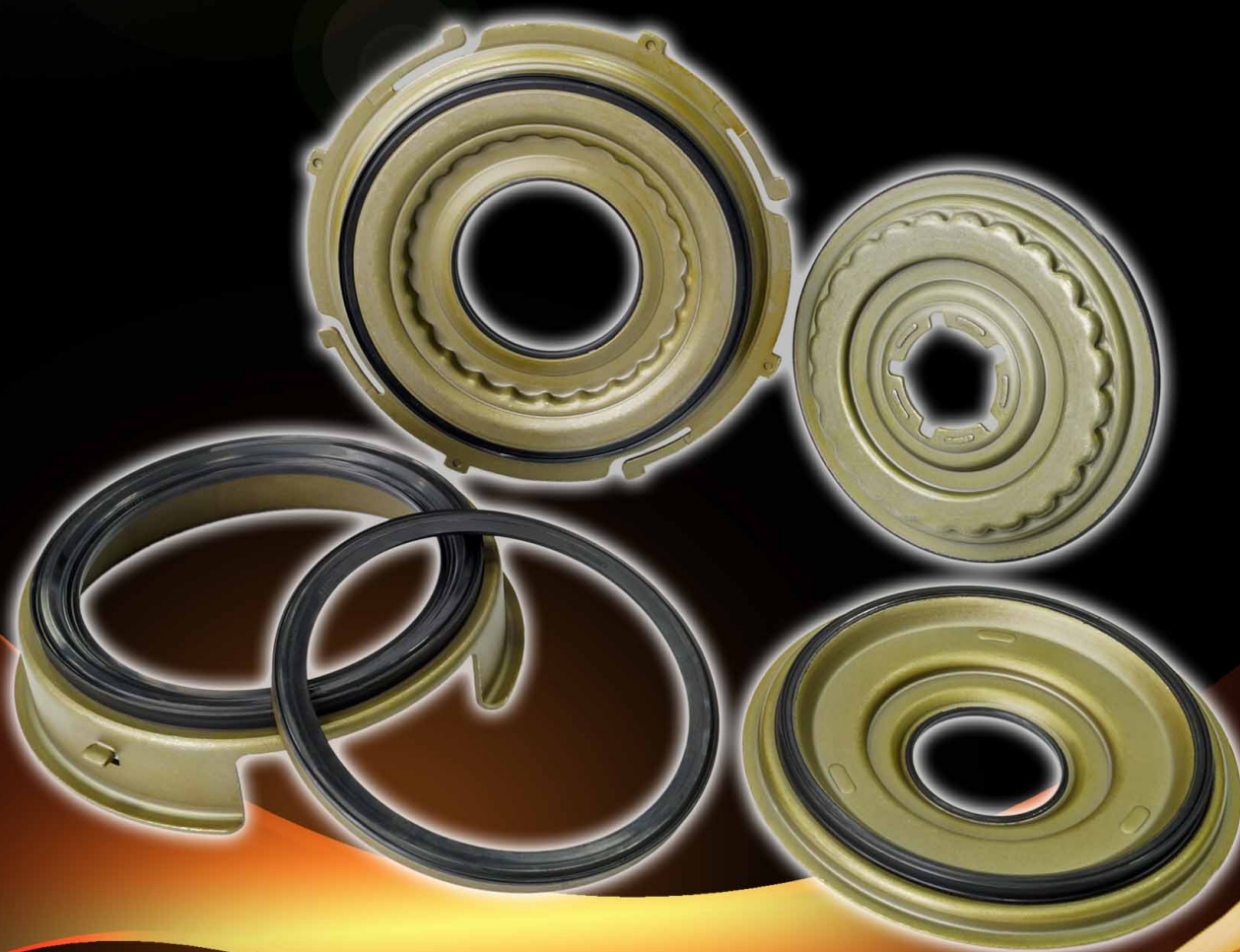

*NAK Transmission Bonded Piston  
Seal Kit*

Automatic transmission is the type of transmission that automatically changes the gears with regard to speed of the vehicle. The primary components of automatic transmission include planetary gear sets, hydraulic system, seals and gaskets, torque converter, governor, modulator and computer.

The modern automatic transmission system comprises many components and devices that are designed to achieve all the sophisticated functions demanded by acute buyers. These components of transmission are required higher stability and response.

To support automatic transmission manufacturers continually developing new designs that accelerate automatic transmission state-of-the-art, NAK has developed a complete range of bonded piston seals for automatic transmission to offer longer service life and technical performance efficiency.

With more than 35 years of experience in manufacturing sealing products, NAK has lots of successful projects of bonded piston seals with international customers all over the world. And now, NAK has developed a broad selection of Bonded Piston Seal Kit which is called TPSK series for Automatic Transmission of American, European and Japanese applications in aftermarket.

Complete TPSK kits with individual vacuum pack make it more convenient for rebuilders to stock and rebuild transmissions.

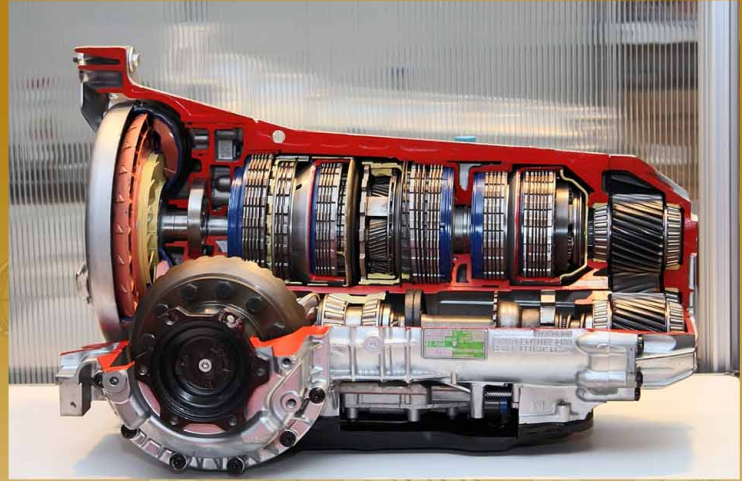

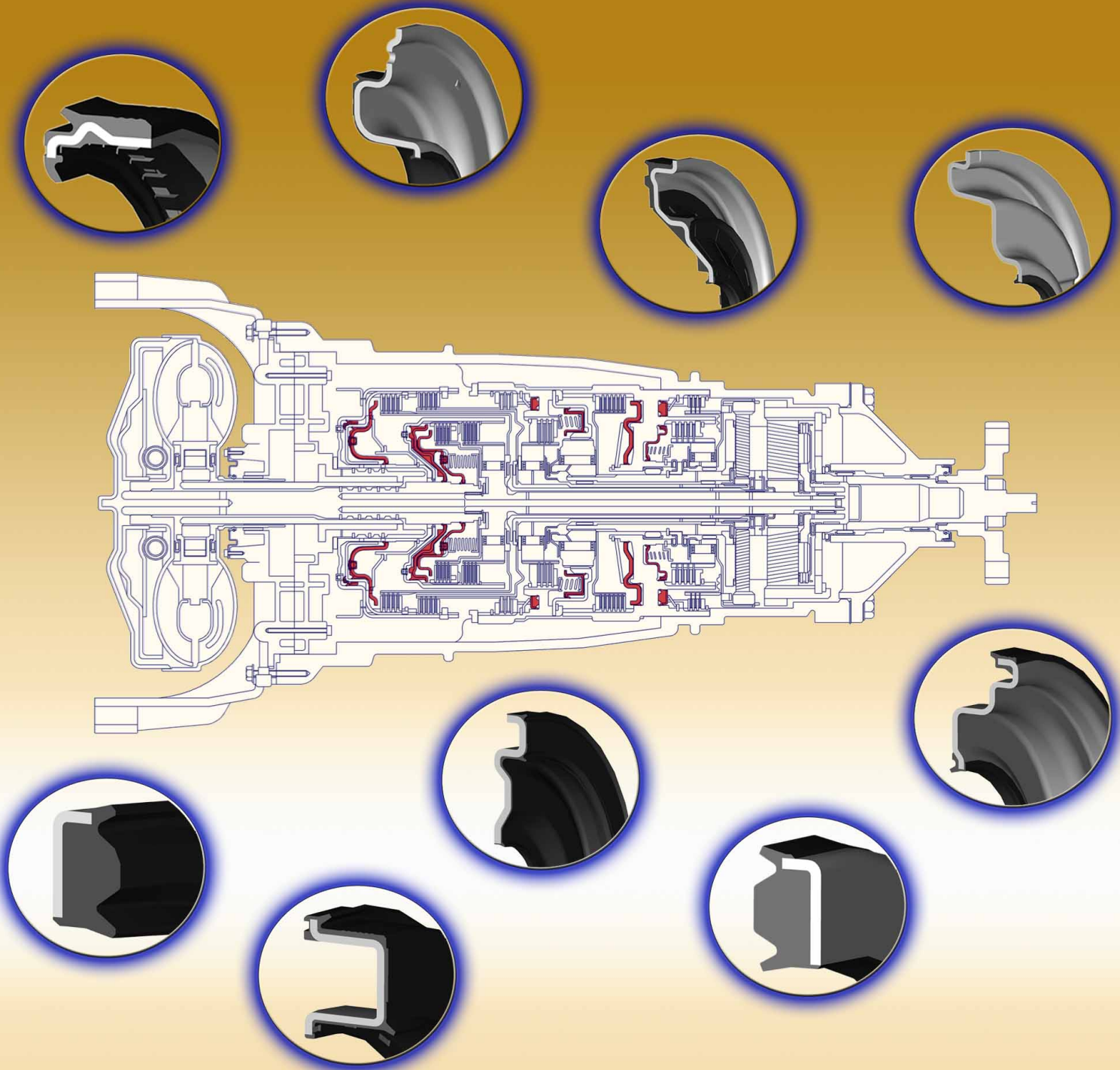

## Benefits:

- ▶ High reliability
- ▶ Cost-effective
- ▶ Ease of installation
- ▶ Integrated characteristics
- ▶ Robust design
- ▶ Weight reduction

NAK Bonded Piston Seals provide good durability functions with consistently low friction, maximum pressure resistance and other strict specification requirements. The one-piece, rubber-to-metal piston seal provides several benefits to transmission manufacturers.

The bonded piston is one-piece versus the 3 to 5 parts needed when utilizing conventional lip seal, O-ring and D-ring designs. It reduces the overall cost, weight, space and simplifies installation procedures. The integral structure also reduces the regular tight tolerances required in machined piston designs while providing greater seal characteristics.

## Struction & Function

While in the manual transmission system, driver drives the vehicle with the help of a hand-operated gearshift and a foot operated clutch. Both types of transmissions make use of a clutch, which allows the gears to be engaged and disengaged. The piston seal is operated by oil pressure and transmits power through engagement with a clutch. And the balancer seal cancels the centrifugal oil pressure generated on the piston side through drum rotation.

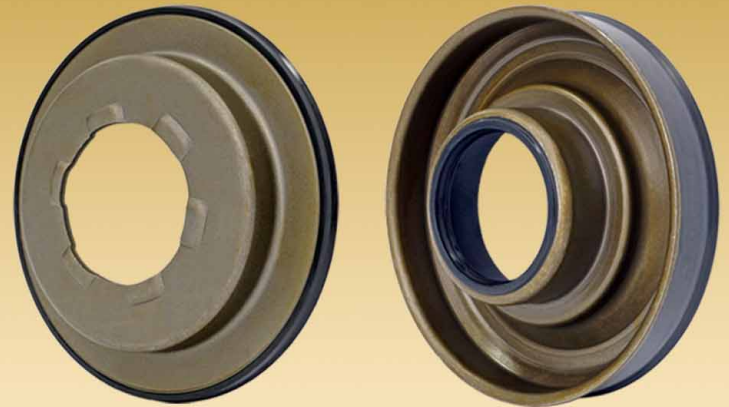
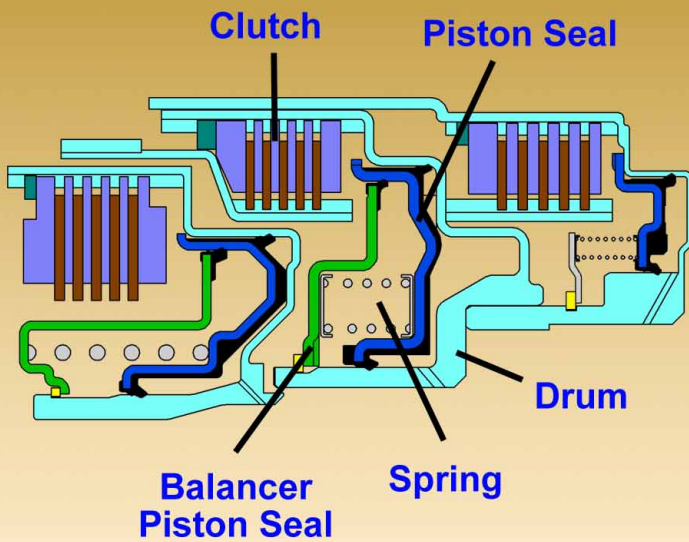

NAK Bonded piston seals for automatic transmission are primarily made out of following materials; Polyacrylate (ACM), Ethylene acrylic (AEM), Hydrogenated Nitrile (HNBR) and Fluorocarbon (FKM). ACM performs excellent resistance to petroleum fuels and oils. AEM exhibits properties similar to those of Polyacrylate (ACM), but with extended low temperature range and with enhanced mechanical properties. HNBR is made from NBR by hydrogenation with high temperature resistance, abrasion resistance and good physical properties. FKM is recommended for applications involving fluids in high operating temperatures. All of these materials listed above perform excellent heat stability and resistance to oil, ozone and temperatures. Additional elastomeric compounds are available to fit different applications.

## Materials

- ▶ Polyacrylate (ACM)
- ▶ Ethylene Acrylic (AEM)
- ▶ Hydrogenated Nitrile (HNBR)
- ▶ Fluorocarbon (FKM)









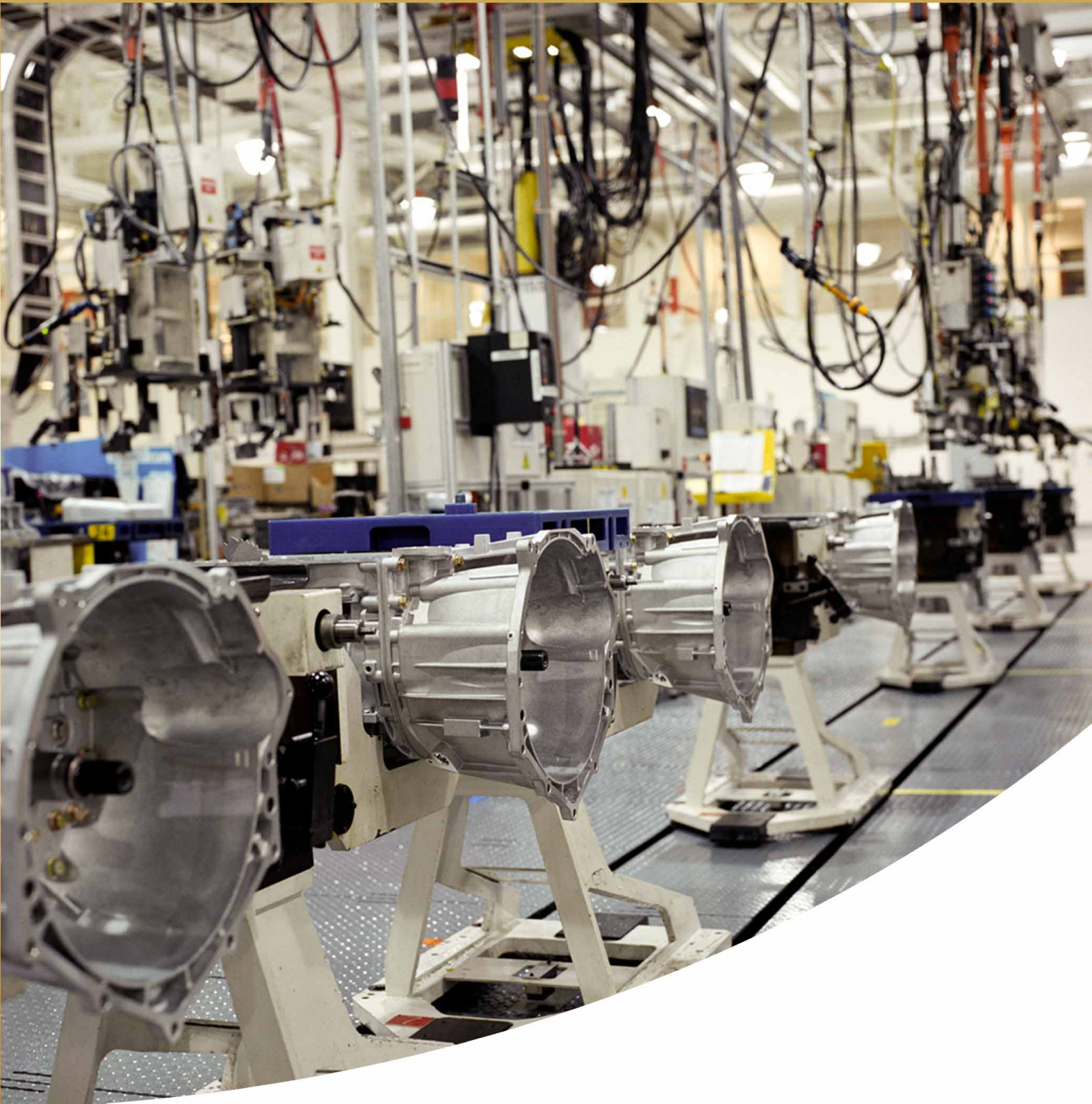







NAK dedicates building the highest quality products for automotive transmissions along with our outstanding technique and customer service. NAK produces and provides OEM quality of all kinds of sealing products for transmissions.

NAK is here for you. We welcome you to order a new open tool product in case there is not in our product list. Please contact us directly or at our website: [www.nak.com.tw](http://www.nak.com.tw)









Item No.	TPSK Kit No.	Photo	Transmission Model	Vehicle	Model
*1	TPSK001		<b>01M/01N/01P (1989-up) 095/096/097/098 (1995-up)</b>	AUDI	A3, A4, A6, AVANT, CABRIOLET, COUPE
				FORD	GALAXY
				MERCEDES BENZ	V-CLASS
				SEAT	ALHAMBRA, TOLEDO
				VOLKSWAGEN	BEETLE, BORA, CABRIO, CARAVELLE, EUROVAN, GOLF, GTI, JETTA, JETTA WAGON, PASSAT, POLO, SHARAN, VENTO
*2	TPSK002		U540E	TOYOTA	PASEO, VIOS, RUSH
*3	TPSK003		ZF4HP16	BUICK	EXCELLE
				CHEVROLET	EPICA, OPTRA, ORLANDO
				DAEWOO	CIELO, LACETTI, LANOS, LEGANZA, MAGNUS, REZZO, TACOMA, VIVANT
				SUZUKI	FORENZA, RENO, VERONA
*4	TPSK004		<b>09G/09K/09M/ TF-60SN/ TF-62SN</b>	AUDI	A2,TT
				BMW	MINI CLUBMAN, MINI COOPER
				SAAB	9'3
				SEAT	ALTEA, LEON, TOLEDO
				SKODA	SUPERB
				VOLKSWAGEN	BEETLE, GOLF, JETTA, PASSAT, TIGUAN, TOURAN, TRANSPORTER
*5	TPSK005		FN4A-EL	MAZDA	2,3,3i, 3S, 3SP23, 323, 5, 6, 6i, 8, ATENZA, AXELA, WAGON, BIANTE, CX7, DEMIO, FAMILIA, MPV(VAN), PREMACY, PROTEGE, TRIBUTE, VERISA
*6	TPSK005A		FN4A-EL	MAZDA	2,3,3i, 3S, 3SP23, 323, 5, 6, 6i, 8, ATENZA, AXELA, WAGON, BIANTE, CX7, DEMIO, FAMILIA, MPV(VAN), PREMACY, PROTEGE, TRIBUTE, VERISA



Item No.	TPSK Kit No.	Photo	Transmission Model	Vehicle	Model
*7	TPSK006		U250E	LEXUS	ES250, ES300, RX330
				PONTIAC	VIBE
				TOYOTA	ALPHARD, CAMRY, COROLLA, HARRIER, HIGHLANDER, IPSUM, KLUGER V, MATRIX, RAV4, SOLARA, VANGUARD, WINDOM
*8	TPSK007		U140E	LEXUS	ES300, RX300
				TOYOTA	CALDINA, CAMRY, ESTIMA, HARRIER, HIGHLANDER, KLUGER V, WINDOM
*9	TPSK008		AL4/DP0	CHERY	A3, A5, APOLA, EASTAR A6
				CITROEN	BERLINGO, C2, C3, C3 PICASSO, C5, C8, C-TRIOMPHE, ELYSEE, EVASION, FUKANG, JUMPY, PALLAS, XANTIA, XM, XSARA, XSARA PICASSO
				FIAT	ULYSSE
				KIA	206 BESTARI
				LANCIA	PHEDRA
				NISSAN	PLATINA
				PERODUA	KELISA, KENARI, VIVA
				PEUGEOT	206, 206SD, 207, 207 PASSION, 306, 307, 308, 406, 406 COUPE, 407, 408, 806, 807, PARS
RENAULT	CLIO, DUSTER, ESPACE, FLUENCE, KANGOO, LAGUNA, LOGAN, MEGANE, MODUS, SAFRANE, SANDERO, SCENIC, SYMBOL, THALIA, SM3				
*10	TPSK009		U660E/U660F	LEXUS	ES, ES350, RX, RX350
				TOYOTA	ALPHARD, AURION, AVALON, AVENSIS, BELDE, BLADE, CAMRY, ESTIMA, HIGHLANDER, MARK X ZIO, RAV4, SIENNA, VANGUARD, VENZA, VERSO

Item No.	TPSK Kit No.	Photo	Transmission Model	Vehicle	Model
*11	TPSK010A		4L40E/ A4S 200R	BMW	3 SERIES
				CADILLAC	CTS, STS, SRX, XLR
				PONTIAC	G8, SOLSTICE
*12	TPSK010		5L40E/ A5S 360R	BMW	3 SERIES, 323i, 325i, 5 SERIES, 525i, 528i, 530i, Ci, Xi, X3, X5, Z3, Z3 ROADSTER, Z4
				BUICK	PARK AVENUE, ROYAUM
				CADILLAC	CTS, SRX, STS
				HOLDEN	ADVENTRA, COMMODORE
				LAND ROVER	RANGE ROVER
				OPEL	GT, OMEGA, OMEGA-B
				PONTIAC	G8, SOLSTICE, GXP, SKY, SKY REDLINE
*13	TPSK010 -Combi		5L40E/ A5S 360R	BMW	3 SERIES, 323i, 325i, 5 SERIES, 525i, 528i, 530i, Ci, Xi, X3, X5, Z3, Z3 ROADSTER, Z4
				BUICK	PARK AVENUE, ROYAUM
				CADILLAC	CTS, SRX, STS
				HOLDEN	ADVENTRA, COMMODORE
				LAND ROVER	RANGE ROVER
				PONTIAC	G8, SOLSTICE, GXP, SKY, SKY REDLINE
*14	TPSK011		ZF4HP20	ALFA ROMEO	166
				BRILLIANCE	BS4
				CITROEN	C5, C8, JUMPER, X1, XANITA, XM, Y4
				FIAT	ALFA, ALPHA, DUCATO, ULYSSE
				FORD	MONDEO
				LANCIA	K, PHEDRA
				MERCEDES BENZ	MB, V CLASS, VITO
				PEUGEOT	406, 406 COUPE, 407, 605, 607, 807
				RENAULT	ESPACE, LAGUNA, MATRA, SAFRANE, X56
				ZHONGHUA	COUPE, FRV, JUNJIE, ZUNCHI





Item No.	TPSK Kit No.	Photo	Transmission Model	Vehicle	Model
*15	TPSK012		6T45E/6T40E	BUICK	ALPHEON, EXCELLE, EXCELLE GT/XT, GL8, LACROSSE, REGAL, VERANO
				CHEVROLET/ GMC/AM GENERAL	CAPTIVA, CAPTIVA SPORT, CRUZE, EPICA, EQUINOX, GENTRA, MALIBU, OPTRA, TERRAIN
				DAEWOO	LACETTI, MPV7, TOSCA, WINSTROM
				OPEL	ANTARA, ASTRA, MERIVA, ZAFIRA
				PONTIAC	G6
				ROEWE	750
				SAAB	9'4x
16	TPSK013		A760E	HONGQI	HQ3, HQE
				LEXUS	GS, GS300, GS350, IS, IS350, LS, LS430, SC, SC430
				TOYOTA	CELSIOR, CENTURY, CROWN, REIZ, SEQUOIA, TUNDRA
17	TPSK014		A960E	LEXUS	GS, GS300, IS, IS250, IS300
				TOYOTA	MARK X, REIZ
*18	TPSK015		4T65E/4T60E	BUICK	CENTURY, CENTURY WAGON, GL8, LACROSSE, ALLURE, LESABRE, LUCERNE, PARK AVENUE, ULTRA, RAINIER, REATTA, REGAL, REGAL GS, REGAL LS, RENDEZVOUS, RENDEZVOUS APV, RIVIERA, SKYLARK, TERRAZA
				CADILLAC	CONCOURS DEVILLE, DEVILLE, ELDORADO, FLEETWOOD, SEVILLE, SEVILLE STS
				CHEVROLET/G MC/AM GENERAL	BERETTA, BLAZER, CORSICA, CAMARO, IMPALA, , MALIBU, MONTE CARLO, UPLANDER, VENTURE APV
				DAEWOO	CIELO
				OLDSMOBILE	88 ROYALE, 98 REGENCY, ACHIEVA, AURORA, CIERA, CUTLASS, CUTLASS CIERA, CUTLASS SUPREME, DELTA ROYALE, EIGHTY EIGHT, INTRIGUE, SILHOUETTE, TORONADO
				PONTIAC	AZTEK, BONNEVILLE, G6, GT, GRAND AM, GRAND PRIX, GTP, MONTANA, SV6, TRANS SPORT
				SATURN	RELAY
VOLVO	CROSS COUNTRY, S80, S90 AWD, XC90				

Item No.	TPSK Kit No.	Photo	Transmission Model	Vehicle	Model
*19	TPSK016		62TE	CHRYSLER	PACIFICA, SEBRING, SEBRING CONVERTIBLE, TOWN & COUNTRY, VOYAGER
				DODGE	AVENGER, AVENGER R/T, CARAVAN, GRAND CARAVAN, JOURNEY
				FIAT	D-CUV
				LANCIA	MPV
				VOLKSWAGEN	ROUTAN
*20	TPSK017		02E (DSG)	AUDI	A3, Q3, TT
				SEAT	ALHAMBRA, ALTEA/XL, LEON, TOLEDO
				SKODA	LAURA, OCTAVIA, SUPERB, YETI
				VOLKSWAGEN	BEETLE, CADDY VAN, EOS, GOLF, GOLF PUS, GTI, JETTA TDI, JETTA WAGON, PASSAT, R32, RABBIT, SCIROCCO, SHARAN, TOURAN, VENTO
*21	TPSK018		U760E	LEXUS	ES, RX, RX270
				SCION	tC
				TOYOTA	CAMRY, HIGHLANDER, RAV4, SIENNA, VANGUARD, VENZA
*22	TPSK019		JF613E	MITSUBISHI	LANCER, OUTLANDER
				NISSAN	MURANO, PATHFINDER, QASHQA, X-TRAIL
				RENAULT	ESPACE, KOLESO, LAGUNA, LAGUNA COUPE, MEGANE, SCENIC
				SAMSUNG	SM5, SM7
*23	TPSK020		6T30E	BAOJUN	630
				BUICK	EXCELLE, EXCELLE GT, EXCELLE HRV
				CHEVROLET/ GMC/AM GENERAL	AVEO, B-CUV, CRUZE, GENRA, LOVA, ORLANDO, SONIC, VIVA
				DAEWOO	GENRA, LACETTI
				HOLDEN	CRUZE
24	TPSK021		4F27E	FORD	ECOSPORT, FESTIVA, FIESTA, FOCUS, FOCUS C-MAX, i-MAX, IXION, LASER, LYNX, TELSTAR, TIERRA, TRANSIT CONNECT, ZX5
				HONGQI	MINGSHI



Item No.	TPSK Kit No.	Photo	Transmission Model	Vehicle	Model
*25	TPSK022		JR405E/ RC4A-EL	CHEVROLET/ GMC/AM GENERAL	COLORADO
				ISUZU	ADVENTURE MASTER, D-MAX, GRAND ADVENTURE, MU-7, SPACE CAB, TROOPER
				MAZDA	BONGO, FRIENDEE, E2000, RX8
				NISSAN	CEDRIC, FAIRLADY Z, LAUREL, SILVIA, SKYLINE, TERRANO II
				SANTANA	300350
				SUZUKI	VITARA
*26	TPSK023		095/096/097/098 (to 1994)	AUDI	80, 90, 100, A6, AVANT, CABRIOLET, COUPE
				SEAT	TOLEDO
				VOLKSWAGEN	CABRIOLET, CARAVELLE, CORRADO, EUROVAN, GOLF, JETTA, PASSAT, TRANSPORTER, VENTO
*27	TPSK024		U240E/U241E	LEXUS	ES250, RX
				SCION	tC, xB
				TOYOTA	ALPHARD, AVALON, CALDINA, CAMRY, CAMRY GRACIA, CELICA, CELICA GTS, COROLLA, CORONA, ESTIMA, GAIA, HARRIER, HIGHLANDER, IPSUM, KLUGER V, MATRIX, RAV4, SCION Tc, SOLARA, VISTA, WINDOM
*28	TPSK025		U150E/U151E/ U151F	LEXUS	ES300, ES330, RX300, RX330, RX350
				TOYOTA	AVALON, AVENSIS, CAMRY, HIGHLANDER, RAV4, SIENNA, SOLARA
29	TPSK026		U440E/U441E/ TF80-40LE/ TF81-40LE	TOYOTA	YARIS, WILL CYPHA, VITZ, TERCEL, PROBOX, PORTE, PLATZ, IST, COROLLA, BELTA, b8
				CHEVROLETE	AVEO
				PONTIAC	G3
				FORD	FIESTA, FUSION
				DAEWOO	KALOS
				SUZUKI	SWIFT

Item No.	TPSK Kit No.	Photo	Transmission Model	Vehicle	Model
30	TPSK027		U340E/U341E	FAW	BESTURN B30, VELA
				SCION	xA, xB, xD
				SUBARU	RACTIS
				TOYOTA	ALLION, AURIS, AVENSIS, BELTA, CALDINA, CELICA, CELICA GT, COROLLA, ECHO, FIELDER, FUNCARGO, ISIS, IST, MATRIX, OPA, PLATZ, PORTE, PREMIO, PROBOX, RACTIS, RAUM, SIENTA, SOLUNA VIOS, SPACIO, SUCCEED, VERSO, VIOS, VITZ, WISH, YARIS
31	TPSK028		010, 087, 089, 090	AUDI	80, 90, 100, 200, 4000, 5000, 5000S, COUPE, FOX
				FIAT	REGATA, STRADA, X1, X9
				PORSCHE	924, 944
				VOLKSWAGEN	CABRIOLET, CAMPER, DASHER, GOLF, JETTA, KOMBI, PICKUP, QUANTUM, RABBIT, SANTANA, SCIROCCO, TRANSPORTER, TYPE 2 BUS, VANAGON
*32	TPSK029		JF011E/ RE0F10A/ F1CJA  (CVT)	DODGE	CALIBER
				DONGFENG	S15
				JEEP	COMPASS, PATRIOT
				MITSUBISHI	CX, DELICA, GALANT FORTIS, LANCER, OUTLANDER, RVR
				NISSAN	ALTIMA, ALTIMA COUPE, BLUEBIRD, BLUEBIRD SYLPHY, DUALIS, ELGRAND, JUKE, LAFESTA, LIVINA GENISS, MAXIMA, MURANO, QASHQAI, QAZANA, ROGUE, SENTRA, SENTRA SE/R, SERENA, SYLPHY, TEANA, TIIDA, VERSA, X-TRAIL
				PEUGEOT	4007
				RENAULT	FLUENCE, KOLEOS, LATITUDE, MEGANE, SCENIC
				SAMSUNG	QM5, SM3, SM5
*33	TPSK030		FS5A-EL	FAW	BESTURN B70
				LINCOLN	MKZ/ZEPHYR
				MAZDA	3, 5, 6, 8, ATENZA, 5HB, WAGON, BIANTE, CX7, MPV(VAN), PREMACY, MILAN
34	TPSK031		FNR5	FORD	FUSION
				LINCOLN	MKZ, ZEPHYR
				MERCURY	MILAN

Item No.	TPSK Kit No.	Photo	Transmission Model	Vehicle	Model
*35	TPSK032		722.6 (Mercedes)	BEIJING	C80
				DODGE	CHALLENGER, CHALLENGER R/T, CHALLENGER SRT8, CHARGER, DURANGO, MAGNUM, NITRO, SPRINTER, SPRINTER VAN
				JAGUAR	XJ8, XJR, XK8
				JEEP	COMMANDER, GRAND CHEROKEE, LIBERTY, WRANGLER
				MAYBACH	57, 57 "SPECIAL", 62, 62 "SPECIAL"
				MERCEDES BENZ	A CLASS, C CLASS, C230, C240, C280, C320, C350, C36, C43, C55, CL, CL500, CL55 AMG, CL600, CL65 AMG, CLC, CLK, CLK430, CLK500, CLK55 AMG, CLS 55 AMG, E CLASS, E220 Cdi, E300, E320, E350, E420, E430, E500, E55 AMG, G WAGEN, G500, G55 AMG, ML CLASS, ML320, ML350, ML430, ML500, ML55, S CLASS, S320, S350, S420, S430, S500, S55 AMG, S600, S65 AMG, SL, SL500, SL55 AMG, SL600, SL65 AMG, BLACK SERIES, SLK, SLK230, SLK32 AMG, SLK350, SLR, SLR MCLAREN, SPRINTER, Vaneo, VIANO, VITO
				PORSCHE	911
				SSANGYONG	CHAIRMAN, KYRON, MUSSO, REXTON, RODIUS
*36	TPSK033		722.6 (Chrysler)	CHRYSLER	300 SERIES, 300C, CROSSFIRE
*37	TPSK034		722.9	MERCEDES BENZ	C CLASS, C230, C280, C350, CL, CL500, CL600, CLC, CLK, CLK350, CLK500, CLK550, CLK63 AMG, CLS, CLS500, CLS550, CLS63 AMG, E CLASS, E320, E350, E500, E550, E63 AMG, G WAGEN, GL CLASS, GL320, GL450, GL550, GLK, GLK VISION, GLK350, ML CLASS, ML320 BLUETEC/CDI, ML350, ML500, ML550, ML63 AMG, R CLASS, R320, R350, R500, R63, S CLASS, S400 HYBRID, S430, S500, S550, SL, SL500, SL550, SLK, SLK280, SLK300, SLK55 AMG, SPRINTER, VIANO, VITO
				SSANGYONG	CHAIRMAN
*38	TPSK035		A4LB1	DAIHATSU	BE-GO, SIRION, TARUNA, TERIOS, DARIO TERIOS
				PERODUA	KEMBARA
				TOYOTA	CAMI, RUSH

Item No.	TPSK Kit No.	Photo	Transmission Model	Vehicle	Model
*39	TPSK036		CD4E/ LA4A-EL 94-97	FORD	CONTOUR, ESCAPE, MONDEO, PROBE
				MAZDA	626, MX6, TRIBUTE
				MERCURY	COUGAR, MARINER, MYSTIQUE
40	TPSK036A		CD4E/ LA4A-EL 98-up	FORD	CONTOUR, ESCAPE, MONDEO, PROBE
				MAZDA	626, MX6, TRIBUTE
				MERCURY	COUGAR, MARINER, MYSTIQUE
*41	TPSK037		RE5R05A	HYUNDAI	GENESIS COUPE, STAREX
				INFINITI	CX35, EX35, FX35, FX45, G35, G37, M35, M45, Q45, QX56
				KIA	BORREGO, MOHAVE, SORENTO
				NISSAN	350ZX, ARMADA, CARAVAN, CIMA, ELGRAND, FAIRLADY Z, ROADSTER, FRONTIER, FUGA, NAVARA, NV, PATHFINDER, PATROL, PRESIDENT, SAFARI, SKYLINE, STAGEA, TERRANO, TITAN, XTERRA, Z
				SUZUKI	EQUATOR
42	TPSK038		4L80E	AM GENERAL	HUMMER (H1)
				ASTON MARTIN	DB7, LOGANDA, LOGANDA VOLANTE, V8 VOLANTE
				BENTLEY	ARNAGE, AZURE, BROOKLANDS, CONTINENTAL, TURBO R
				CADILLAC	CONCOURS, SEVILLE, DEVILLE, DTS, ELDORADO, LIVERY, HEARSE, LIMO
				CHEVROLET/ GMC/AM GENERAL	CK BLAZER, C/K PICK-UP 1500-2500, H1 HUMMER, SILVERADO 1500 HD, SILVERADO 2500, SILVERADO 3500, SIERRA 2500, SIERRA DENALI, SUBURBAN 1500, SUBURBAN 2500, TAHOE, TRUCK (C/K SERIES), VAN FULL SIZE 2500, VAN FULL SIZE 3500, YUKON 2500, YUKON DENALI, YUKON XL
				ISUZU	NPR TRUCK, TRUCK NPR, W4
				JAGUAR	XJ12, XJR, XJS
				ROLLS ROYCE	ARNAGE, CORNICHE, SILVER DOWN, SILVER SERAPH, SILVER SPIRIT, SILVER SPUR, TURBO COUPE
*43	TPSK039		SR410/SR412	SUZUKI	ALTO, WAGON R, JIMNY
*44	TPSK040		A172/A174/ TW40E	SUZUKI	CARIBIAN, CARRY BUS, PICKUP, E-RV, ESCUDO, EVERY, JIMNY, LANDY

Item No.	TPSK Kit No.	Photo	Transmission Model	Vehicle	Model
*45	TPSK041		JF405E	DAEWOO	MATIZ
				HYUNDAI	ATOZ, SANTRO
				KIA	MORNING, PICANTO, VISTO
				MAZDA	AZ WAGON, LAPUTA, SPIANO
				NISSAN	MARCH, MOCO, PINO
				OPEL	AGILA
				SUZUKI	ALTO, CERVO, CULTUS, KEI, LAPIN, MR WAGON, PALETTE, SOLIO, WAGON R
46	TPSK042		5R55N	FORD	THUNDERBIRD
				JAGUAR	S TYPE, XK8, XKR
				LINCOLN	LS
47	TPSK043		5R55S/ 5R55W	FORD	EVEREST, EXPLORER, EXPLORER SPORT TRAC, FALCON, MUSTANG, RANGER, TERRITORY, THUNDERBIRD
				LINCOLN	AVIATOR, LS
				MAZDA	BT-50, PICKUP B SERIES
				MERCURY	MOUNTAINEER
*48	TPSK044		JF010/RE0F09A (CVT)	NISSAN	ALTIMA, ELGRAND, MAXIMA, MURANO, PRESAGE, QUEST, TEANA
				RENAULT	MEGANE, SCENIC
*49	TPSK045		A6MF1, 2, 3	HYUNDAI	AVANTE MD, ELANTRA, GRANDEUR, i30, ix35, SANTA FE, SONATA, TUCSON ix, VERNA
				KIA/NAZA	CARENS, FORTE, K5, LOTZE, OPIRUS, OPTIMA, SORENTO, SOUL, SPORTAGE
*50	TPSK046		JF506E/RE5F01A	AUDI	A3
				FORD	GAIAXY, MONDEO
				JAGUAR	X TYPE
				LAND ROVER	FREELANDER
				MAZDA	5, 6, 6S, ATENZA WAGON, MPV(VAN)
				MG	7
				MITSUBISHI	380, ECLIPSE, ECLIPSE SPYDER, GALANT, MAGNA
				NISSAN	ALTIMA, MAXIMA, QUEST
				ROVER	45, 75, 400
				SEAT	ALHAMBRA
				VOLKSWAGEN	BORA, GOLF, GTI, JETTA, JETTA WAGON, SHARAN, SHARAN 4 MOTION

Item No.	TPSK Kit No.	Photo	Transmission Model	Vehicle	Model
*51	TPSK047		6L45E/6L50E	BUICK	PARK AVENUE
				CADILLAC	ATS, CTS, CTS COUPE, SPORT WAGON, SRX, STS, XLR
				CHEVROLET / GMC/AM GENERAL	CAMARO
				HOLDEN	COMMODORE
				PONTIAC	G8
52	TPSK048		A5CF1/A5CF2	HYUNDAI	SONATA
				KIA	FORTE, K7, LOTZE
*53	TPSK049		JF015E (CVT7)	CITROEN	RVR
				MITSUBISHI	A-HATCH, LANCER, RVR
				NISSAN/ DATSUN	BLUEBIRD SYLPHY, CUBE JUKE, MARCH, MICRA, NOTE, QASHQAI, TIIDA
				SAMSUNG	SM3
				SUZUKI	ALTO, LAPIN, MR WAGON, PALETTE, SOLIO, SWIFT, WAGON R
*54	TPSK050		K310 (CVT)	TOYOTA	ALLION, AURIS, AVENSIS, COROLLA, EZ, ISIS, IST, PREMIO, PROBOX, RUMION, SUCCEED, WISH
*55	TPSK051		TF70SC/AT6	PEUGEOT	308, 3008
				CITROEN	C5, DS4
56	TPSK052		845RE	CHRYSLER	300 V6, 300C V6
				DODGE	CHARGER V6
				RAM	1500 V6 (2013- )
				BMW	1 SERIES(F20), 5 SERIES(F10)
				JEEP	GRAND CHEROKEE(WK2) 3.6
57	TPSK053		42RLE	CHRYSLER	300 SERIES
				DODGE	CHALLENGER, CHALLENGER SE, CHARGER, DOKOTA, PICKUP, DURANGO, MAGNUM, NITRO
				JEEP	CHEROKEE, GRAND CHEROKEE, LIBERTY, WRANGLER, WRANGLER UNLIMITED
				MITSUBISHI	ENDEAVOR, RAIDER



Item No.	TPSK Kit No.	Photo	Transmission Model	Vehicle	Model
*58	TPSK054		JR710E/JR711E RE7R01A	INFINITI	EX37,FX50,G37
*59	TPSK055		0B5 (DL501)	AUDI	A4(B8), A5, CABRIOLET(S4/S5), Q5
*60	TPSK056		MPS6 (CHRYSLER) / 7M5R (FORD)	FORD	C-MAX, ECOSPORT, FIESTA, GALAXY, KUGA, LAND ROVER, MONDEO, S-MAX, FOCUS
				VOLVO	C30, C70, S40, S60, S80, V50, V60, V70
61	TPSK057		8HP45	BMW	1 SERIES (F20), 5 SERIES (F10)
				CHRYSLER	300 V6
				DODGE	CHARGER V6, RAM 1500 V6
*62	TPSK058		TF80-SC (AM6 PEUGEOT) (AF40 GM, VOLVO) TF81SC (AF21 FORD)	FORD	TF81SC (AF21/AWF21) 6 SPEED, MERCURY MILAN, MONTEGO, FIVE HUNDRED, FREESTYLE, FUSION (USA ONLY), TF80SC (AF40/AF4)
				SAAB	9-3 06-11, 9-5, 10-11
				VOLVO	TF81SC (AF21/AWF21), TF80SC (AF40/AF4), V70R, V70, XC 90, S60, S60R, S80
63	TPSK059		A6GF1, 2, 3	HYUNDAI	ELANTRA, ACCENT 1.6L GDI
				KIA	FORTE, SOUL, RIO, GDI
61	TPSK060		A6LF1, 2, 3	HYUNDAI	AZERA, SANTAFE, SONATA
				KIA	CARENS, GRAND CARNIVAL, LOTZE, OPIRUS, SORENTO, SPORTAGE
62	TPSK061		AB60F	TOYOTA	TUNDRA, SEQUOIA, LEXUS
63	TPSK062		QR640AHA	GEELY	EC7 SEDAN, GLEAGLE GX7 SUV, SC5-RV

Item No.	TPSK Kit No.	Photo	Transmission Model	Vehicle	Model
64	TPSK063		6T70E/6T75E (Ford 6F50)	FORD	EDGE, ESCAPE, FLEX, FUSION, LINCOLN MKX/ MKS/ MKZ, TAURUS/ X, MERCURY SABLE/ MARINER/ MILAN
				CHEVROLET	EQUINOX, MALIBU, TRAVERSE, IMPALA
				CADILLAC	SRX
				GMC	ACADIA
				BUICK	ENCLAVE, LACROSSE
				MAZDA	TRIBUTE
				PONTIAC	G6 GTP/ GXP, TORRENT GXP
				SATURN	AURA XR (LY7 V6 OPTION), OUTLOOK
65	TPSK064		6F35	FORD	EDGE, TAURUS, AURUS X, FLEX, ESCAPE, FUSION MERCURY MILAN, SABLE, MARINER LINCOLN MKX, MKS, MKZ
				SATURN	AURA/ OUTLOOK
				MAZDA	TRIBUTE
				GMC	ACADIA
				BUICK	ENCLAVE, LACROSSE
				CHEVROLET	EQUINOX, TRAVERSE, MALIBU, IMPALA
				PONTIAC	G6 GTP, G6 GXP, Torrent GXP
66	TPSK065		RE0F21A RE0F08A (JF009E)	NISSAN	VERSA, MARCH, CUBE, NOTE, TIIDA, LATIO, WINGROAD, MICRA
				FIAT	PUNTO



## Subsidiary map

### Existing subsidiaries worldwide

● Factory

● Service office & warehouse

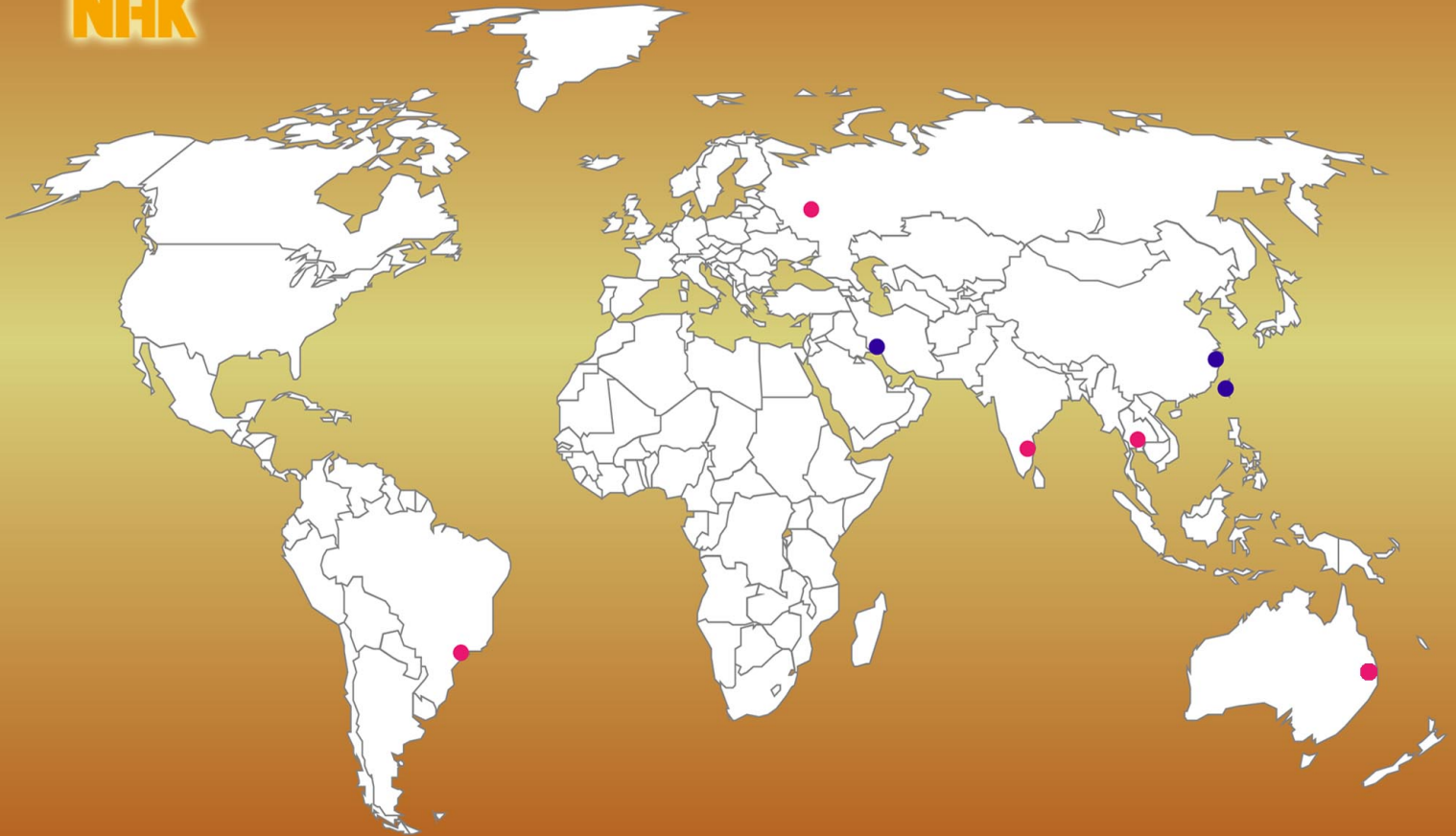

#### Taiwan (NAK Headquarters)

**NAK SEALING TECHNOLOGIES CORPORATION**  
No.336, Industrial Road, Nankang Industrial Zone, Nantou  
City 54065, Taiwan  
TEL : 886-49-2255011  
FAX : 886-49-2250035  
E-mail : service@mail.nak.com.tw  
www.nak.com.tw



#### China

**KUNSHAN MAOSHUN SEALING PRODUCTS INDUSTRIAL CO., LTD.**  
No.271, Xingpu Road, Zhoushi Town, Kun Shan City,  
Jiangsu Prov., China 215337  
TEL : 86-512-57666240; 86-512-57665788  
FAX : 86-512-57665827; 86-512-57664409  
E-mail : sales@nak.com.cn  
www.ksnak.com



#### Iran

**KISH NAK OIL SEAL MFG. CO., LTD.**  
No.67, Eshghyar St. Khorramshahr Ave.,  
Tehran 15339, Iran  
TEL : 98-21-88761965  
FAX : 98-21-88741319  
E-mail : kishnak@parsonline.net



#### Thailand

**NAK SEALING PRODUCTS(THAILAND) CO., LTD.**  
120/36 Moo 12 Soi 21/2 Kingkaew-Bangplee Road, Tumbul  
Rachatewa, Ampur Bangplee Samutprakarn 10540, Thailand  
TEL : 66-2-750-1988  
FAX : 66-2-750-1868  
E-mail : sales@mail.thainak.com



#### Russia

**NAK INTERNATIONAL LTD.**  
Russia, Postal Index 143956, Moscow Region, Balashiha,  
Mikroaion Nikolsko-Arhangelskiy, Vishnyakovskoe Shosse,  
56, "NAK INTERNATIONAL LTD."  
TEL : 7-495-545-94-00  
FAX : 7-495-646-79-29  
E-mail : info@naksealing.ru  
www.naksealing.ru



#### India

**NAK SEALING TECHNOLOGIES (INDIA) PRIVATE LIMITED**  
P-1, Phase II, Dr.Vikram Sarabhai Industrial Estate,  
Thiruvanniyur, Chennai - 600 041, Tamilnadu, India.  
TEL : 91-44-64586657; 91-44-64586661  
FAX : 91-44-24540254  
E-mail : marketing@nakindia.com



#### Brazil

**NAK DO BRASIL INDUSTRIA E COMERCIO DE COMPONENTES DE VEDACAO LTDA**  
Rua Soldado Benedito Eliseo Dos Santos, NRO 10 CEP  
02177-020, Sao Paulo S.P, Brazil  
TEL : 55-11-3807-3001  
FAX : 55-11-3807-3002  
E-mail : nakbrasil@nakbrasil.com.br  
comercial@nakbrasil.com.br



#### Australia

**NAK TOTAL SEALING SOLUTIONS AUSTRALIA**  
Unit 1-17 Buttonwood Place,  
Willawong QLD 4110, Australia  
TEL : 617-3161-5210  
FAX : 612-6674-2516  
E-mail : sales@sealingtechnologies.net  
www.naksealingtechnologies.com



#### Disclaimer

1. NAK products are not intended to be used, installed or applied in or on any aerospace related instruments and/or equipment. Any such use, installation, or application is prohibited and shall void all warranties.
2. NAK disclaims any and all express or implied warranties if the products :
  - 2.1 are modified or tampered with;
  - 2.2 are misused, abused or misapplied;
  - 2.3 are used in a critical environment or specific equipment without NAK's prior written consent;
  - 2.4 are not used in accordance with the printed user instruction materials; or
  - 2.5 are damaged due to natural deterioration, decomposition or transformation of chemical structure.
3. The products may be applied in critical environment or specific equipment only upon official confirmation of the sample by NAK's technical personnel and the passing of tests conducted by buyer.